

UNCTAD MONOGRAPHS ON PORT MANAGEMENT

*A series of monographs prepared for UNCTAD in collaboration
with the International Association of Ports and Harbors (IAPH)*

Supplement to Monograph No. 5 Container terminal pavement management

by

*Marios Meletiou
B.Sc.(Tech.), Honours, M.Sc., M.B.A.
Head of Civil Engineering Section
Cyprus Ports Authority*

and

*John Knapton
B.SC., Ph.D., C.Eng., MICE, MIHT, FFB
Director
John Knapton Consulting Engineers Limited*



**UNITED NATIONS
New York, 1990**

NOTE

The views expressed in this monograph are those of the authors and do not necessarily reflect those of the United Nations. The designations employed and the presentation of the material in this publication do not imply the expression of any opinion whatsoever on the part of the Secretariat of the United Nations concerning the legal status of any country, territory, city or area or of its authorities, or concerning the delimitation of its frontiers or boundaries.

*

* *

Other monographs in this series

- No. 1 Changing from day-work plus overtime to two-shift working
- No. 2 Planning land use in port areas: getting the most out of port infrastructure
- No. 3 Steps to effective equipment maintenance
- No. 4 Operations planning in ports
- No. 5 Container terminal pavement management
- No. 6 Measuring and evaluating port performance and productivity
- No. 7 Steps to effective shed management

UNCTAD/SHIP/494(5)/Supp.1

INTRODUCTION TO THE SERIES

In the ports of industrialized countries, operating systems and personnel development are based on skills acquired through experience, on emulation of other industries and on the innovation which is easily undertaken in advanced industrial environments. These means are generally lacking in developing countries, and port improvements occur only after much deliberation and often through a process of trial and error. Some means are required by which ports in developing countries can acquire skills that are taken for granted in countries with a long industrial history, or can learn from the experience of others of new developments and how to meet them.

Formal training is one aspect of this, and UNCTAD has devoted considerable effort to developing and conducting port training courses and seminars for senior management and to preparing training materials to enable middle-management courses to be conducted by local instructors. It was felt that an additional contribution would be the availability of clearly written technical papers devoted to common problems in the management and operation of ports. The sort of text that will capture an audience in the ports of developing countries has to be directed at that very audience, and very few such texts exist today.

Following the endorsement of this proposal by the UNCTAD Committee on Shipping in its resolution 35 (IX), the UNCTAD secretariat decided to seek the collaboration of the International Association of Ports and Harbors, a non-governmental organization having consultative status with UNCTAD, with a view to producing such technical papers. The present series of UNCTAD Monographs on Port Management represents the results of this collaboration. It is hoped that the dissemination of the materials contained in these monographs will contribute to the development of the management skills on which the efficiency of ports in developing countries largely depends.

A. Bouayad
Director
Shipping Division
UNCTAD

FOREWORD

When UNCTAD first decided to seek the co-operation of the International Association of Ports and Harbors in producing monographs on port management, the idea was enthusiastically welcomed as a further step forward in the provision of information to managements of ports in developing countries. The preparation of monographs through the IAPH Committee on International Port Development has drawn on the resources of IAPH member ports of industrialized countries and on the willingness of ports in developed countries to record for the benefit of others the experience and lessons learnt in reaching current levels of port technology and management. In addition, valuable assistance has been given by senior management in ports of developing countries in assessing the value of the monographs at the drafting stage.

I am confident that the UNCTAD monograph series will be of value to management of ports in developing countries in providing indicators towards decision-making for improvements, technological advance and optimum use of existing resources.

The International Association of Ports and Harbors looks forward to continued co-operation with UNCTAD in the preparation of many more papers in the monograph series and expresses the hope that the series will fill a gap in the information currently available to port managements.

C. Bert Kruk
Chairman
Committee on International
Port Development
IAPH

CONTENTS

Chapter	Paragraphs
OVERVIEW	(i)-(vii)
I. INTRODUCTION	1 - 10
II. NEW CONTAINER TERMINAL PAVEMENT CONSTRUCTION	11 - 55
MATERIALS AND METHODS	
A. Introduction	11 - 14
B. Recent developments in paving blocks	15 - 19
C. Steel fibrous concrete pavements	20 - 36
1. General	20 - 21
2. Hooked steel fibres glued in bundles	22 - 25
3. Properties and advantages of steel fibre reinforced concrete pavements	26 - 36
D. Semi-rigid floating pavement	37 - 46
E. Roller compacted concrete pavements	47 - 48
F. Revised table on suitability of pavements	49 - 55
III. NEW MAINTENANCE, REHABILITATION AND UPGRADING METHODS	56 - 75
A. Rapid repair material for pavements	56 - 70
B. New generation geotextiles for overlay techniques	71 - 75
IV. REVISED BRITISH PORT FEDERATION (BPF) PORT PAVEMENT	76 - 87
DESIGN MANUAL	
A. Introduction	76
B. Revised presentation of design charts	77 - 78
C. Technical changes	79 - 87

OVERVIEW

- (i) This *Supplement to Monograph No. 5* is intended to bring readers up-to-date with the recent advances in the field of container terminal paving which promise to exert a positive influence over port pavement management, the focus of the original Monograph.
- (ii) The new edition of the British Port Federation's (BPF) Manual *The Structural Design of Heavy Duty Pavements for Ports and Other Industries* has been a key influence on the production of this new Supplement. Published in early 1989, the role of this publication is to provide port paving engineers with a proven design methodology while the role of *Monograph No. 5* and this *Supplement* is complementary in that it presents a comprehensive overview of port paving from every perspective necessary to achieve effective pavement management - from the selection through to the maintenance and upgrade stages. This Supplement highlights the new construction materials and methods mentioned in the second edition of the BPF Paving Manual, as well as some additional new construction materials and methods recently tried or under trial in some ports, and reviews them from its own unique perspective of paving management.
- (iii) It has been widely acknowledged that the two publications - *The Structural Design of Heavy Duty Pavements for Ports and Other Industries* Manual and *Monograph No. 5* have played a complementary role in providing an informed insight into port paving and it is believed by the authors that this new *Supplement* maintains this positive momentum. Marios Meletiou, lead author of *Monograph No. 5* and this *Supplement* has collaborated closely with Dr. John Knapton in the production of both works and in turn Marios Meletiou has cooperated closely with John Knapton in the production of the new updated edition of the BPF Paving Manual.
- (iv) Throughout, the authors have given consideration to practical advances achieved in the field, as well as new design thinking and modifications to existing theory.
- (v) The following *Supplement* combines, therefore, an overview of all the important advances in port pavement management at both a theoretical and practical level. It is intended that it will help to further raise the awareness of the importance of port paving in the port management process.
- (vi) The attention of readers is drawn to the World Bank and UNCTAD's training material on *Operating and Maintenance Features of Container Handling Systems*, which comprises a two-hour video and a manual of some 90 pages prepared by Portrain UK Ltd. in 1987. The material, available only in English, can be purchased from the UNCTAD secretariat and provides information to assist Governments and port authorities in the selection of equipment for the development of container handling facilities. The UNCTAD secretariat has also developed training materials on *Development of Container Terminals (IPP2)* and *Management of Container Terminal Operations (Trainmar 02.6)*. Information on the use of these materials can be obtained from the UNCTAD secretariat.
- (vii) The authors would like to express their thanks to all parties who have assisted in the production of this Supplement and particular thanks to the industry journal *Port Development International*, which has lent its support throughout the process.

Chapter I

INTRODUCTION

1. Recent years have witnessed a considerable growth in the importance of container terminal paving mainly because of diverse major pavement failures leading to serious problems. For the purposes of this *Supplement* the term "failure" is not confined to structural but also extends to financial and operational aspects.

2. Inevitably, pavement failures present a challenge to the port engineering community, which, in turn, leads to a search for new pavement construction methods, materials and the further refinement of design methods, thus offering greater choice of pavement type as well as more accurate and realistic pavement design. This *Supplement*, which briefly covers the most recent ideas and developments in connection with container terminal port pavements, aims to enhance the picture presented in the original Monograph of the paving options currently available.

3. In Monograph No. 5 the following materials/construction methods are described.

- Bituminous or asphalt surfacing
- In situ concrete
- Pre-cast concrete rafts
- Concrete paving blocks
- Gravel beds

4. Since the publication of the Monograph the authors have gained further experience on some of the above materials/construction methods. Additionally, they have learnt of other new systems currently emerging in the port industry. In the light of this experience, the following adds to the comments made in the original Monograph on materials/construction methods and the next chapter reviews major new developments.

Bituminous or asphalt surfacing

5. Further experience of this type of pavement has not revealed anything new but just confirmed what has been stated in the original Monograph.

In situ Concrete

6. To a large extent the same comment applies as for bituminous surfacing above, with the exception of the following:

- (a) Previously it was recommended that a high concrete strength of at least 30 N/mm² is necessary to reduce spalling and impact damage. Further experience, however, suggests the recommended value should be 40 N/mm². The second edition of the BPF Design Manual includes design charts based on this increased value.
- (b) In situ concrete port pavements are now classified in two main categories, namely, conventionally reinforced in situ concrete pavements (top mesh 4.34 kg/m²) and steel fibre reinforced concrete, a new method. Both types are covered in the new edition of the BPF Design Manual which includes two different curves on the design charts, one for each case. The steel fibrous concrete pavement is described in the next chapter.

Precast concrete rafts

7. Their days have gone, i.e. they no longer offer a feasible solution. This is the result of the disadvantages of the system highlighted in paragraph 67 of the original Monograph, which are summarized in this document (see paragraph 39).

Concrete paving blocks

8. As time passes this pavement system steadily increases its "market share" in container terminal pavement coverage, especially in North Western Europe. Here the system has more or less established itself as the standard solution for container terminals. Recent developments in paving blocks are described in the next chapter.

Gravel beds

9. The popularity of gravel beds for container stacking zones has increased significantly and there is strong evidence that it will continue to do so in the future. This has been the result of the positive experience of the various ports that have applied the system. For example, after a second phase of expansion, gravel beds at the port of Penang, Malaysia, now cover an area equivalent to 3,000 TEU slots. Port executives report the excellent engineering and operational performance of the system and it further exhibits major cost savings in terms of initial construction and maintenance compared to alternative methods of construction. Construction costs were Mal \$10.76/m² compared to Mal \$32.28/m² for bitumen and Mal \$107.60/m² for concrete slabs, i.e. the paving systems adopted prior to the construction of gravel beds (at the end of 1985 the exchange rate was 2.43 Mal \$ per US \$).

10. Ports/terminals where gravel beds are presently in use or under construction include in approximate chronological order:

- Ashdod (Israel)
- Limassol (Cyprus)
- Hong Kong - Kwai Chung TS - MTL (Hong Kong)
- Rotterdam - Quick Dispatch (Netherlands)
- Dusseldorf - DCD (Federal Republic of Germany)
- Penang -PPC (Malaysia)
- Haifa (Israel)
- Nhava Sheva (India)
- Singapore - Pilot scheme (Singapore)
- Isle of Grain (U.K.)
- Rotterdam - ECT (New SeaLand Terminal) (Netherlands)

Recent reports also suggest that gravel beds are now being considered for use in ports in Turkey, the Caribbean and the United Arab Emirates.

Chapter II

NEW CONTAINER TERMINAL PAVEMENT CONSTRUCTION MATERIALS AND METHODS

A. Introduction

11. The introduction of new container terminal pavement construction materials and methods is inherently a slow process. Nevertheless, since the time of the publication of the original monograph there has been a particularly productive period in this respect. A number of new materials and methods have emerged that are eminently worthy of review in this Supplement. One of these materials, steel fibrous concrete, has been introduced by the two authors into the new edition of the BPF design manual. Two other new pavement construction methods, the so-called semi-rigid floating pavement and roller compacted concrete, also appear to hold potential for use as container terminal pavements.

12. In each of these three cases, it is significant to note that there have been actual on-site applications of the system in the port environment. This makes them all extremely eligible for discussion in this Supplement. Container terminal designers should be aware of these new materials and construction methods, which may eventually prove to be the appropriate ones to meet their specific requirements.

B. Recent developments in paving blocks

13. First used in northern European ports, concrete paving blocks have gained worldwide recognition as an important industrial paving surfacing material. With their introduction to North America has come the need for labour saving installation techniques and this has led to the development of paving blocks specifically for mechanical laying. The unit shown in figure 1 is just such a block. Its shape allows it to be positioned by machine and its "crinkle-out" edges allow up to 30 units to be held together whilst they are swung directly from pallet to the pavement surface. Developments have also been taking place in relation to rectangular blocks, which are still the most common unit. In particular, spacers have been integrally introduced as a means of avoiding block cracking and spalling. Spacers usually take the form shown in figure 2.

14. Typically, machines such as those shown in figure 3 are capable of installing 700m² in an 8-hour shift. Such machines can work in parallel so that the potential speed of laying is virtually limitless, being dependent on site preparation and block supply rather than installation.

15. As pavement loading increases, block thickness is increasing and the once almost universal 80mm thick blocks are being replaced by 100mm, and in some cases 120mm thick blocks. The authors have found 80mm thick rectangular blocks with plan dimensions of 100mm x 200mm to be satisfactory in all normal loading regimes, particularly in relation to container handling operations.

16. The semi-rigid floating system is a paving block system which has recently been introduced in Valencia (Spain) and this system is described in section D of this chapter.

17. Other changes in blocks have been the development of national standards and the establishment of a group to produce a European standard. In general, these standards specify strength, either by compressive testing or by flexural tensile testing and durability. The principal difference between national standards lies in their approach to ensuring durability. In some, a minimum cement content is specified whilst in others a freeze/thaw test is specified. The correlation between strength and durability has not yet been established.

C. Steel fibrous concrete pavements

1. General

18. The introduction of steel fibrous concrete into the port arena holds the potential to considerably raise the cost effectiveness and performance of concrete port pavements, thus making this type of pavement more competitive. The system is based on the use of steel fibres along with cement, fine and coarse aggregates and water in order to produce a composite material,

Figure 1
Paving block with "crinkle-out" edges

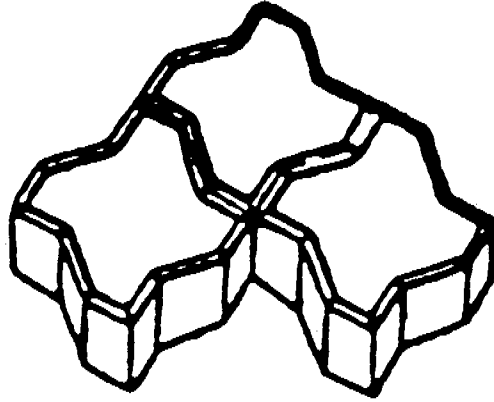

Figure 2
Rectangular paving blocks with integral spacers

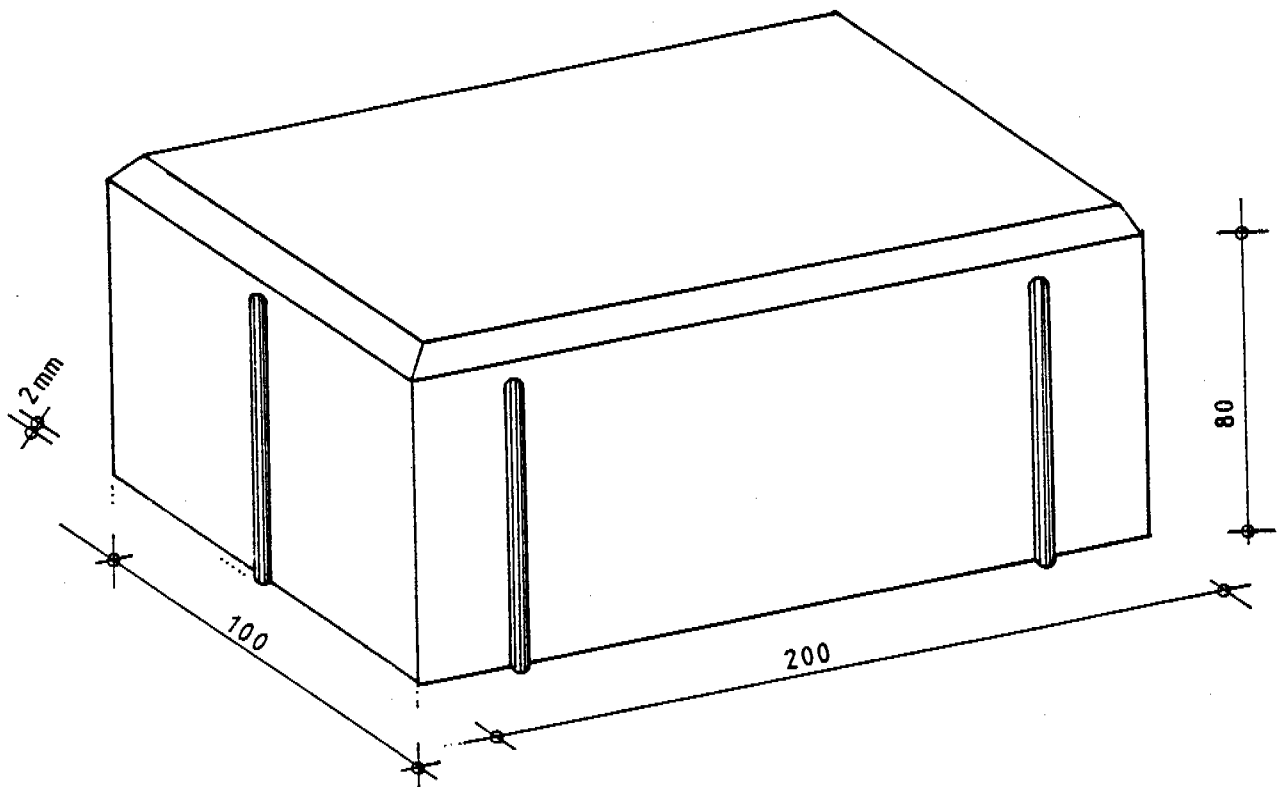
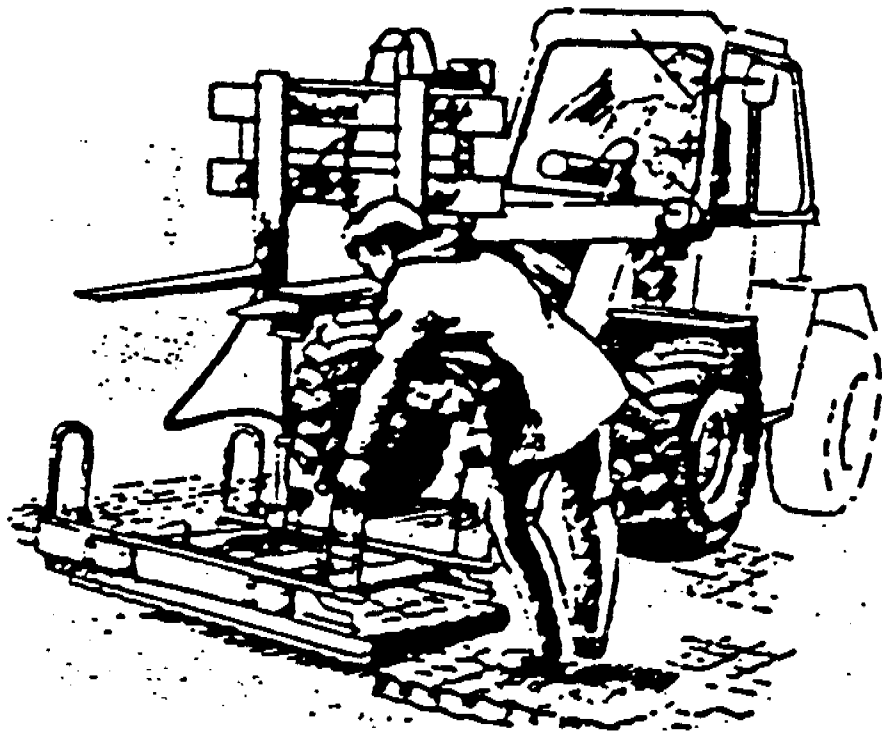
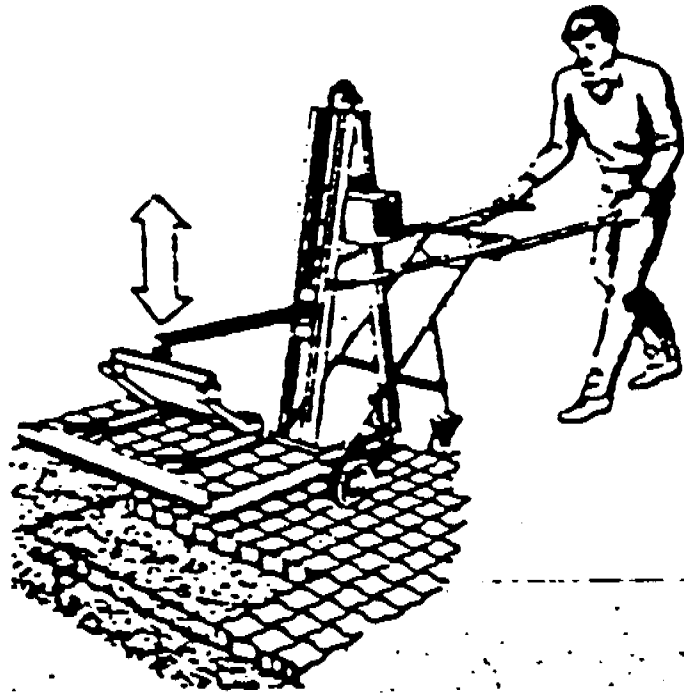

Figure 3
Machines for laying paving blocks



which is called Steel Fibrous Concrete (SFC). This special reinforced concrete material possesses much better mechanical and physical properties than conventional concrete.

19. The successful application of this new technology in a large number of industrial and airport pavements during the last decade, which are subjected to loads of the same magnitude as port pavements, has proven the tremendous advantages of SFC over conventional concrete, as well as other traditional types of pavements. These advantages have recently been widely acknowledged by the port industry and this has, in turn, led to the adoption of this type of heavy duty pavement in a number of ports such as the Port of Ghent (Belgium), Port of Limassol (Cyprus) and Port of Algeciras (Spain) where these pavements have been in operation since 1985 (see figure 4).

2. Hooked steel fibres glued in bundles

20. The most efficient and generally successful type of steel fibres employed in reinforced concrete are those produced from drawn steel wire (usual diameter 0.6mm and length 80mm) with hooked ends (offering strong mechanical anchorage in the concrete). They are glued together into small bundles, thus avoiding the "balling effect" and causing no difficulty in mixing which can be the case with separate/individual fibres.

21. These hooked and glued steel fibres (see figure 5) are added in bundles, containing approximately 30 fibres, as an extra aggregate and require no special equipment other than that which is normally used for concrete mixing. Gluing the loose steel fibres together creates a compact bundle form which makes it possible to mix steel fibres of longer lengths and consequently greater reinforcing capacity. These bundles can be added to the dry aggregates as well as to the already mixed concrete. As soon as the mixing process starts, the bundles spread throughout the entire mass and since the glue is water soluble, the steel fibres, owing to the action of the moisture in the mixture and the scouring effect of the aggregates, separate again into individual steel fibres (see figure 6). This guarantees a homogeneous mixture.

22. These specially shaped fibres are made from hard drawn steel wire and have a typical tensile strength of 1,200 N/mm². They can be proportioned into mixes at about 60 per cent of the quantity otherwise required for straight fibres.

23. It should be noted that the following discussion relates to this particular shaped type of steel fibres of which the authors have personal experience and it may, therefore, not be wholly applicable to other types of steel fibres.

3. Properties and advantages of steel fibre reinforced concrete pavements

24. The inclusion of steel fibres in the concrete matrix alters the properties of the resulting composite material. The ductile, high tensile strength fibres compensate for the low tensile strength and low ductility of the concrete, and enhance the mechanical and physical properties of the composite. Properties such as fatigue endurance, impact resistance (see figure 7) and toughness are considerably improved. The tensile and flexural strength of steel fibre reinforced concrete is also substantially increased. The strength and ability of fibres to resist crack propagation depend primarily on the bond between the fibres and the concrete (fibre shape), as well as the fibre spacing (aspect ratio and fibre dosage).

25. The ductility of fibrous concrete is greater than that of plain concrete. As figure 8 shows, steel fibrous concrete still has considerable load carrying capacity after initial cracking. For plain concrete, the first crack and ultimate strength are synonymous, but for fibrous concrete, the cracks cannot extend without stretching or debonding the fibres. Consequently, additional energy is required before the ultimate stress and complete fracture occurs. After the ultimate load is reached, the load begins to decrease but catastrophic failure does not occur at this point either.

26. Another property of steel fibre reinforced concrete which makes it superior to plain concrete is the resistance to spalling and wear. There is no quantitative measure for spall resistance, but qualitatively this property can be determined from results of dynamic and explosive loading tests. These show that fibrous concrete does not disintegrate upon loading but is held together by the fibres.

Figure 4
Steel fibrous concrete pavements at Algeciras container terminal

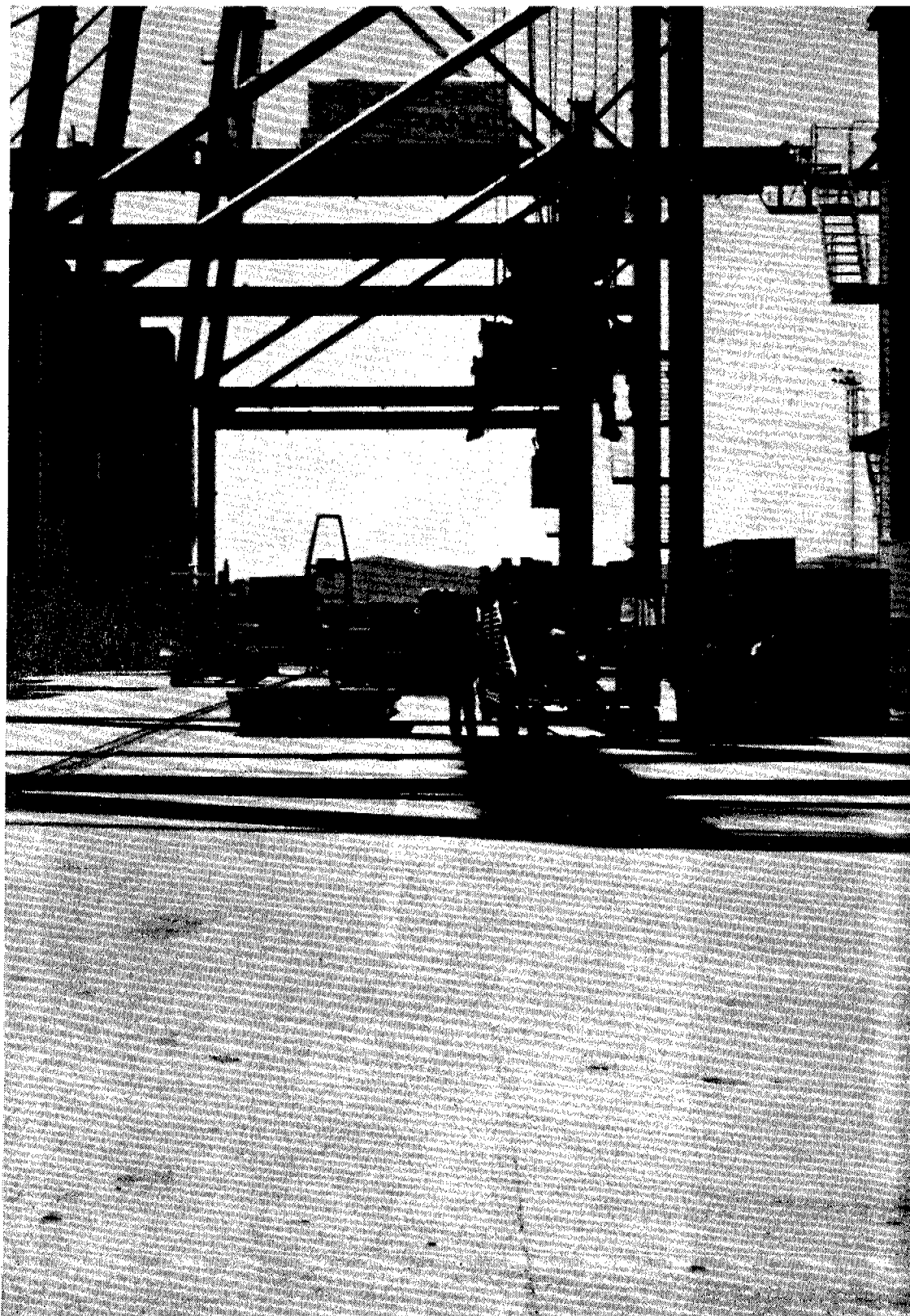

Figure 5
Glued bundles of steel fibres

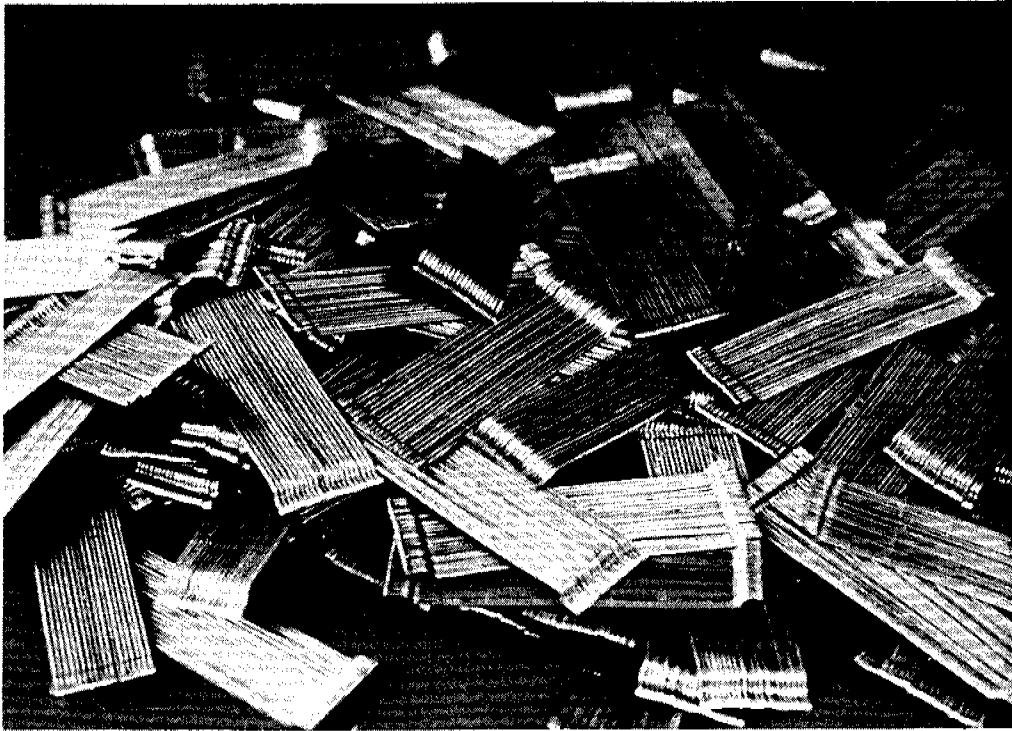

Figure 6
Concrete mix showing dispersion of steel fibres



Figure 7
Impact resistance of various concretes

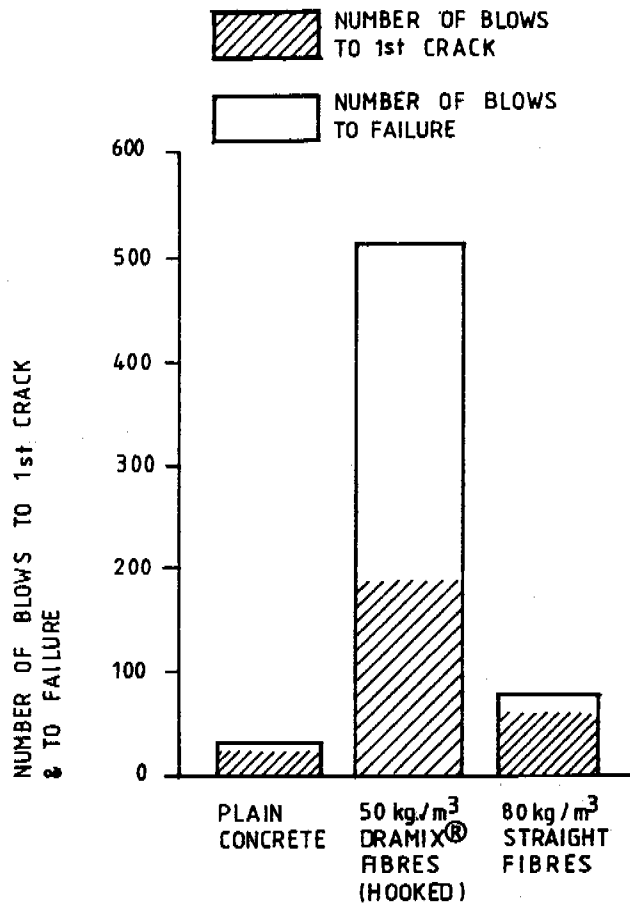
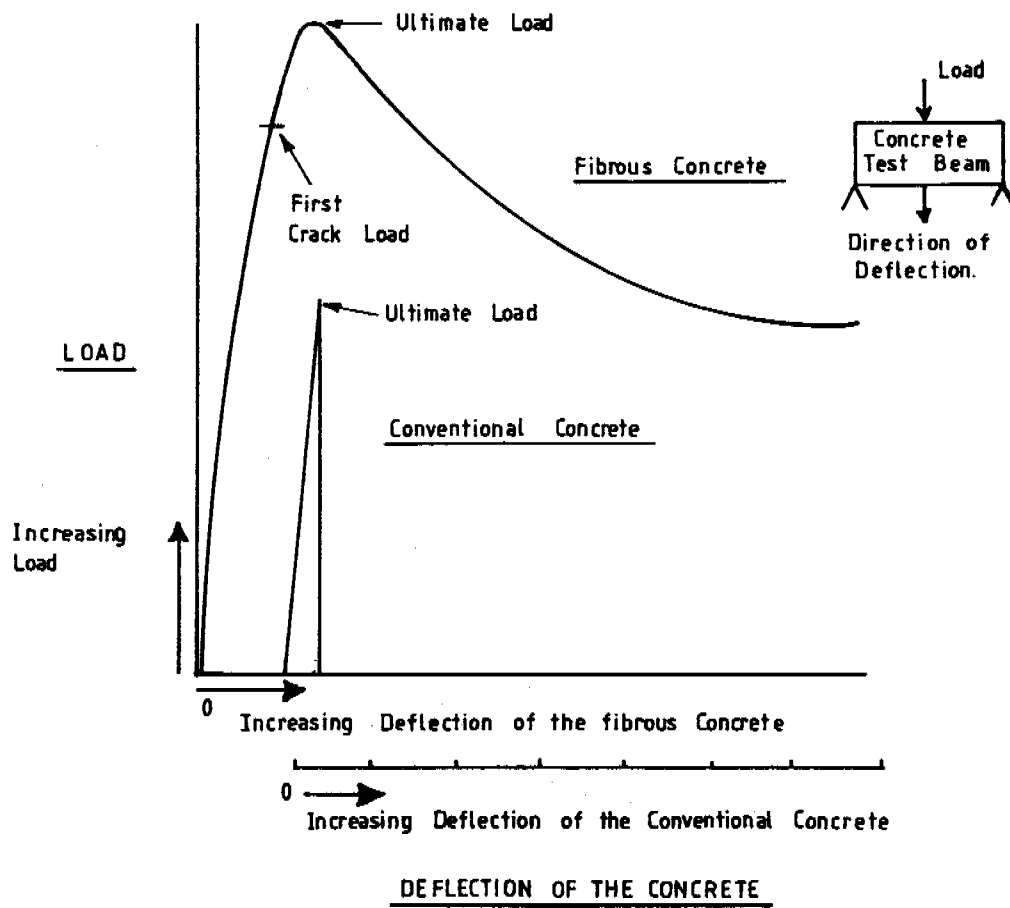

Figure 8
Typical load versus deflection curves for conventional and fibrous concretes



27. The requirements imposed on port pavements are many and quite high but with regard to loading these can be grouped in two categories:

- Dynamic loads from vehicles and particularly from large handling equipment (container handling equipment causes the most severe loading);
- Static concentrated loads or uniform loads from containers or other types of cargo stored in ports.

28. A heavy duty port pavement will normally be submitted to tensile stresses on both the upper and under sides of the concrete slab. The location of these stresses may change whenever the place of the loaded zones changes. It is, however, not a simple task to absorb such tensile stresses by rod or mesh reinforcement. In practice, it is not always easy to place mesh reinforcement and keep it in the correct position when the concrete is being poured, especially with two layers of reinforcement. Common practice with conventional reinforced concrete pavements is for the concrete casting operation to be carried out in two stages to facilitate the correct placement of reinforcement. Steel fibres reinforce the concrete in the mass. This means that the pavement is able to absorb stresses of equal magnitude on both the upper and under sides of the slab.

29. Direct pouring of concrete in one stage on the compacted sub-base, covered with polyethelene sheets, may offer substantial gains in time. Problems with storing and placing the reinforcement are thus avoided. A smaller pavement thickness will always be possible because of the higher flexural strength and better fatigue resistance of the material. This, not only offers savings in material costs, but also reduces construction time, and offers important labour savings compared to traditional concrete pavement construction.

30. Moreover, by better absorbing and distributing the shrinkage stresses it is possible to increase the joint spacings by 50 per cent or more compared to conventional concrete pavement construction, thus increasing further the cost savings. As an example, in the Port of Limasol the joint spacing was increased from 5 meters to 7.5 meters (see figure 9).

31. Basically two types of port pavements can be considered for reinforcement with steel fibres:

- (a) New pavements on prepared surfaces;
- (b) Relatively thin overlays, bonded or unbonded to existing pavements, either for changing to new required levels or for strengthening or rehabilitation purposes.

In both cases, and particularly in case (b), the smaller thicknesses that can be achieved compared to other types of pavement construction, of similar performance and strength, are of great advantage in the hands of port engineers.

32. The advantages of the steel fibrous reinforced concrete system can be summarised as follows:

- (a) Greater tensile, flexural (especially effective flexural), compressive and shear strength;
- (b) Higher resistance to spalling;
- (c) Higher fatigue resistance;
- (d) Greater toughness;
- (e) Greater impact resistance against static and dynamic loading;
- (f) Superior ductility (strain capacity);
- (g) Greater ability to carry loads when cracked;
- (h) Better resistance against crack formation and propagation;
- (i) Simplicity as extremely suitable for placement by slip-form paver and other standard road construction machinery (see figure 10);

Figure 9
Cutting joints in steel fibrous concrete pavement at the port of Limassol

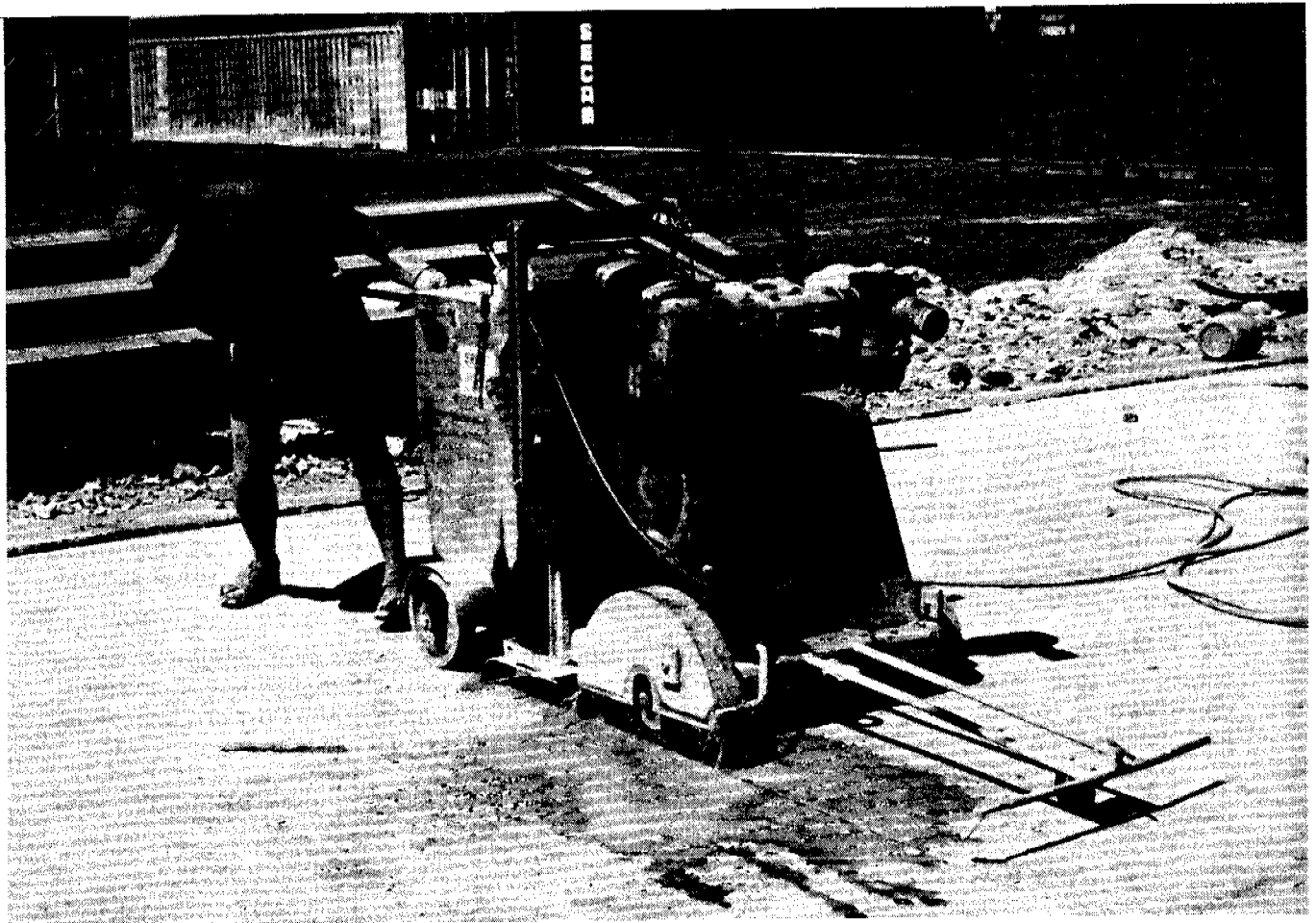
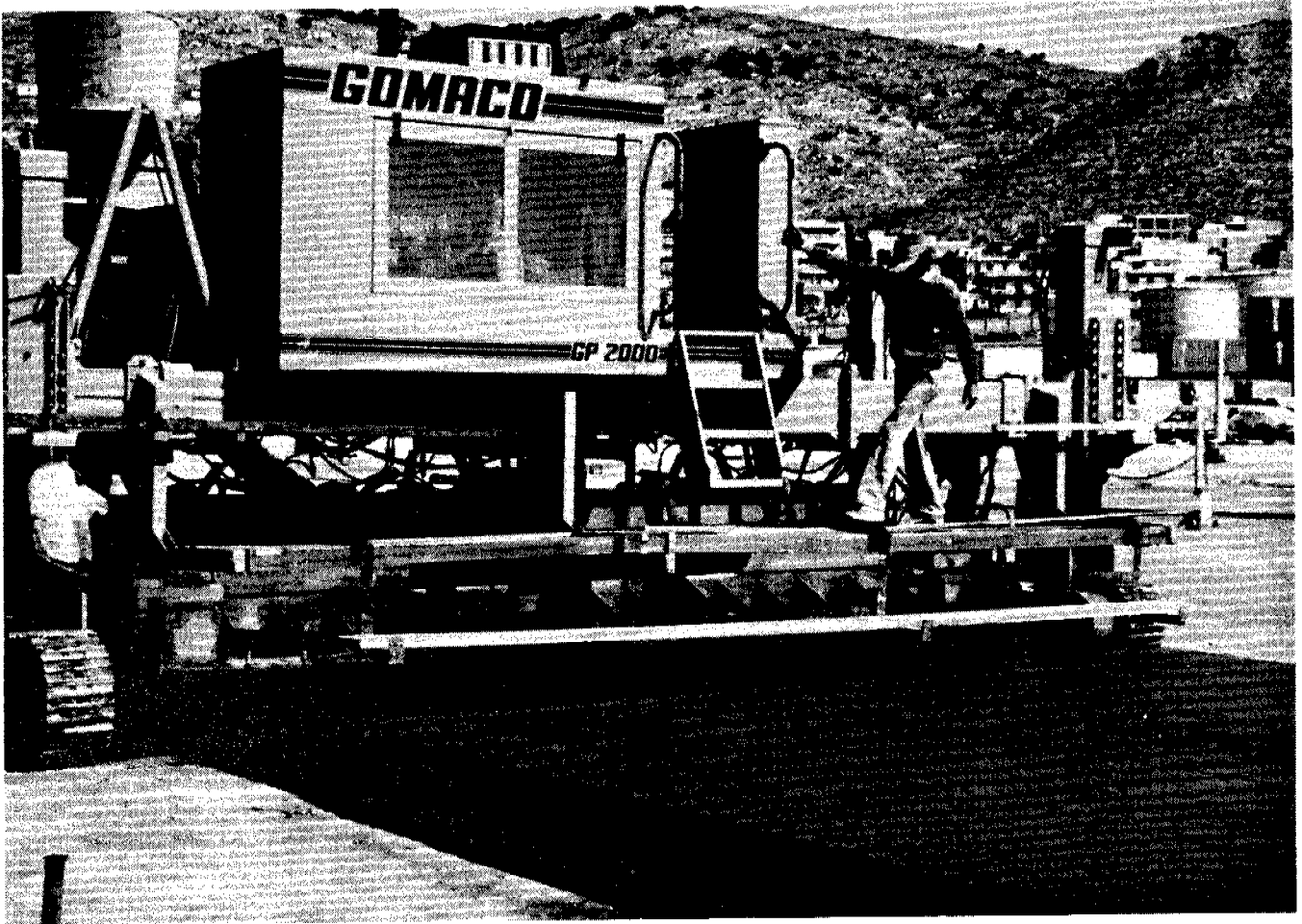

Figure 10
Steel fibrous concrete being laid with a slip-form paver at the
new container terminal in the port of Piraeus



- (j) Savings in maintenance and a longer useful life;
- (k) Greater initial strength and early availability for service;
- (l) Reduced work in maintaining relative levels when applying; overlays due to the smaller thickness of steel fibre reinforced concrete;
- (m) Greater distance between expansion joints.

D. Semi-rigid floating pavement

33. This newly developed heavy duty pavement system (see figure 11) has many similarities with the non-feasible precast concrete raft system, referred to earlier. The new system, however, retains all its predecessor's advantages while dispensing with all its drawbacks. This ingenious design also adds a number of key advantages of its own.

34. The semi-rigid floating pavement is made up of the following basic components.

- Precast concrete units: the units are either reinforced or more commonly non-reinforced, of a size and shape shown in figure 12. These units can be mass reinforced with steel fibres to give thinner and lighter sections offering increased impact resistance, ductility, etc..
- Rubber joints: the joints of the shape and size shown in figure 13. These are placed *alternately* around adjacent units and are fitted in special grooves formed during prefabrication. The main functions of the rubber joints are to join the units together; absorb the deformation of the sand which supports the concrete units when they are subjected to surface loading, make the pavement waterproof (i.e. prevent penetration of water into the subgrade through the joints) and to transfer and distribute the applied load to the adjacent units thus minimising the pressure exerted on the ground.
- Sand: The units are laid on a layer of sand to give uniform bedding (see figure 14). Sand also fills up the inner cavity of the units through the orifice provided for this purpose (this orifice is also used for lifting purposes and after placement is sealed) and offers additional support and stability to the units. In the event of any undesirable differential or uniform settlement, sand can be injected through the orifice after removal of the seal (which typically is made from bituminous or other easily removable but impermeable material).

35. The injection of the sand through the orifice is efficiently and easily achieved with the use of a simple screw type drill which assists in filling all cavities (see figure 15). After completing the sand injection, the final operation is to apply a vibrating roller to the pavement (figure 16).

36. The high quality concrete units provide the required rigidity. At the same time, however, the system itself, due to the closely spaced rubber joints, offers a considerable degree of flexibility. Thus the system is described as semi-rigid.

37. This paving system is also described as "floating" due to its spring effect, brought about as a result of the combined effect of the rubber joints and sand bedding - i.e. on the application of a load a given unit and surrounding units will settle a little bit and then once the load is removed the pavement will move back to its original level.

38. Long-term trials of this pavement system at the new east wharf in the port of Valencia, Spain, clearly demonstrate this spring effect, as well as the ability of the system to successfully handle both heavy moving and static loads. One of the authors has witnessed the good performance of this system. It is also clearer at this stage how precisely the disadvantages of the original precast concrete raft system are minimized and the advantages are maximized.

39. The disadvantages of the precast concrete raft system were highlighted in paragraph 67 of the original Monograph and are recapped briefly here:

Figure 11
Field testing of semi-rigid floating pavement system at the
port of Valencia

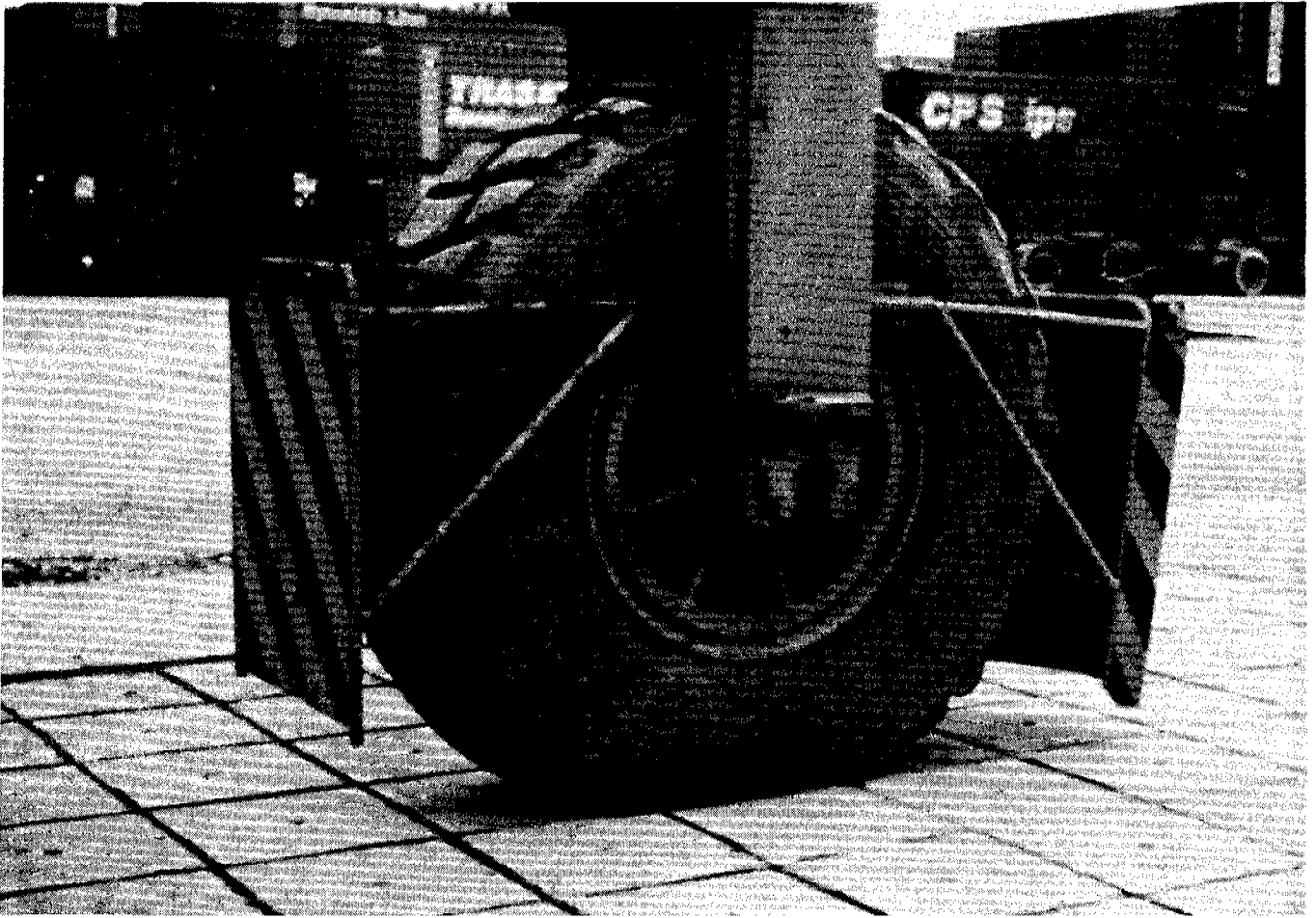

Figure 12
Precast concrete unit for semi-rigid floating pavement

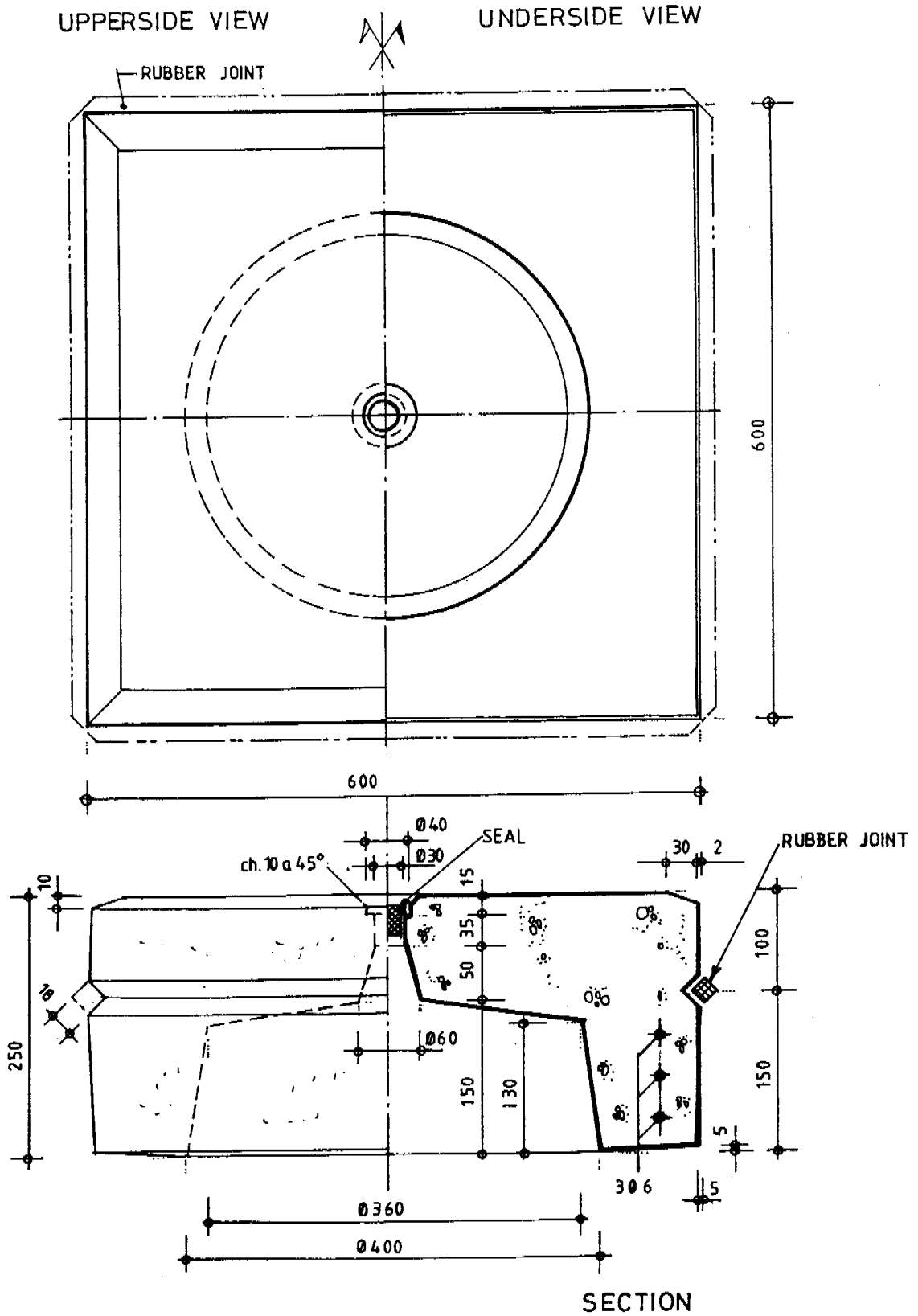

Figure 13
Rubber joints for semi-rigid floating pavement



Figure 14
Installation of precast units on a layer of sand and showing
alternative placement of rubber joints

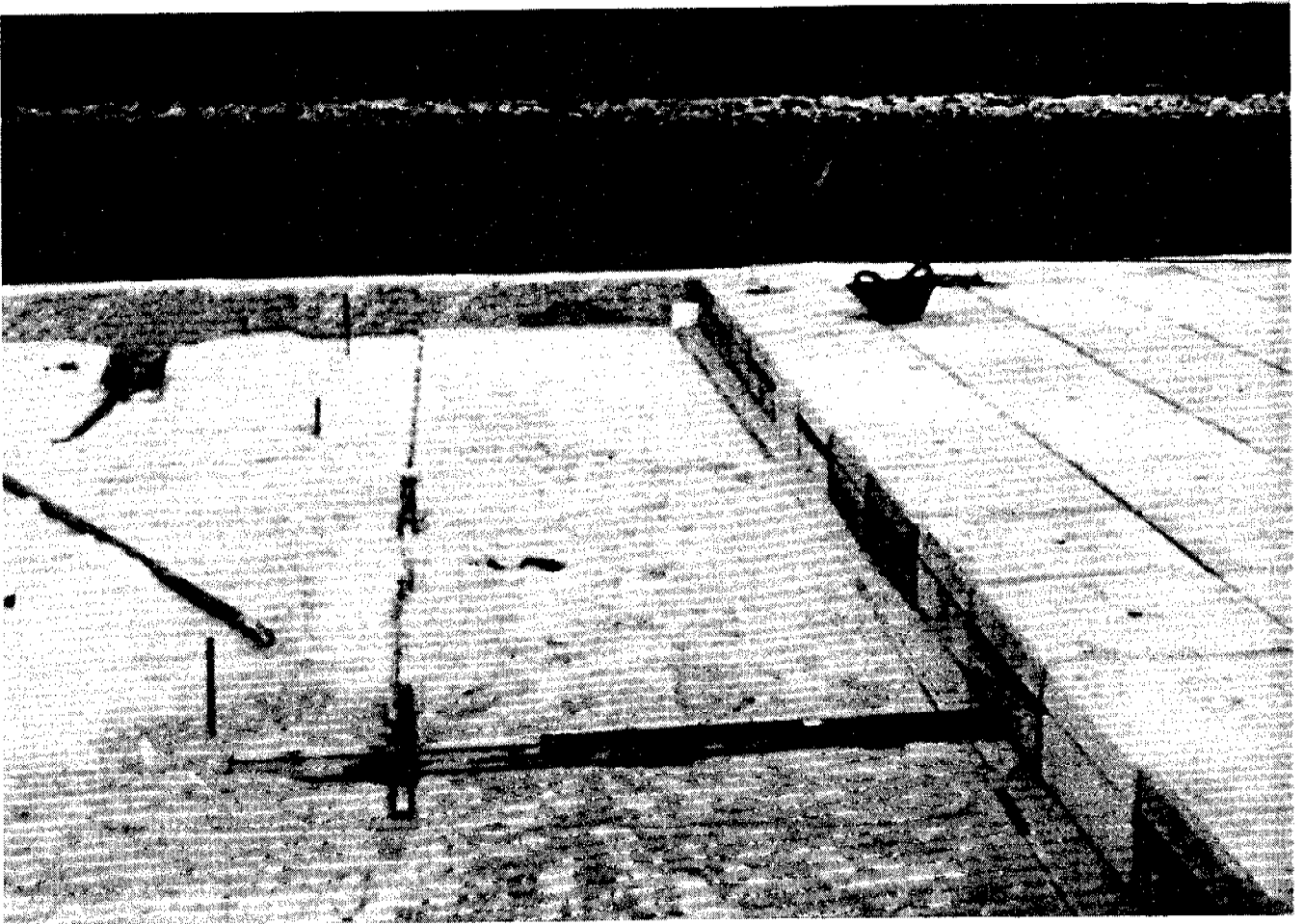
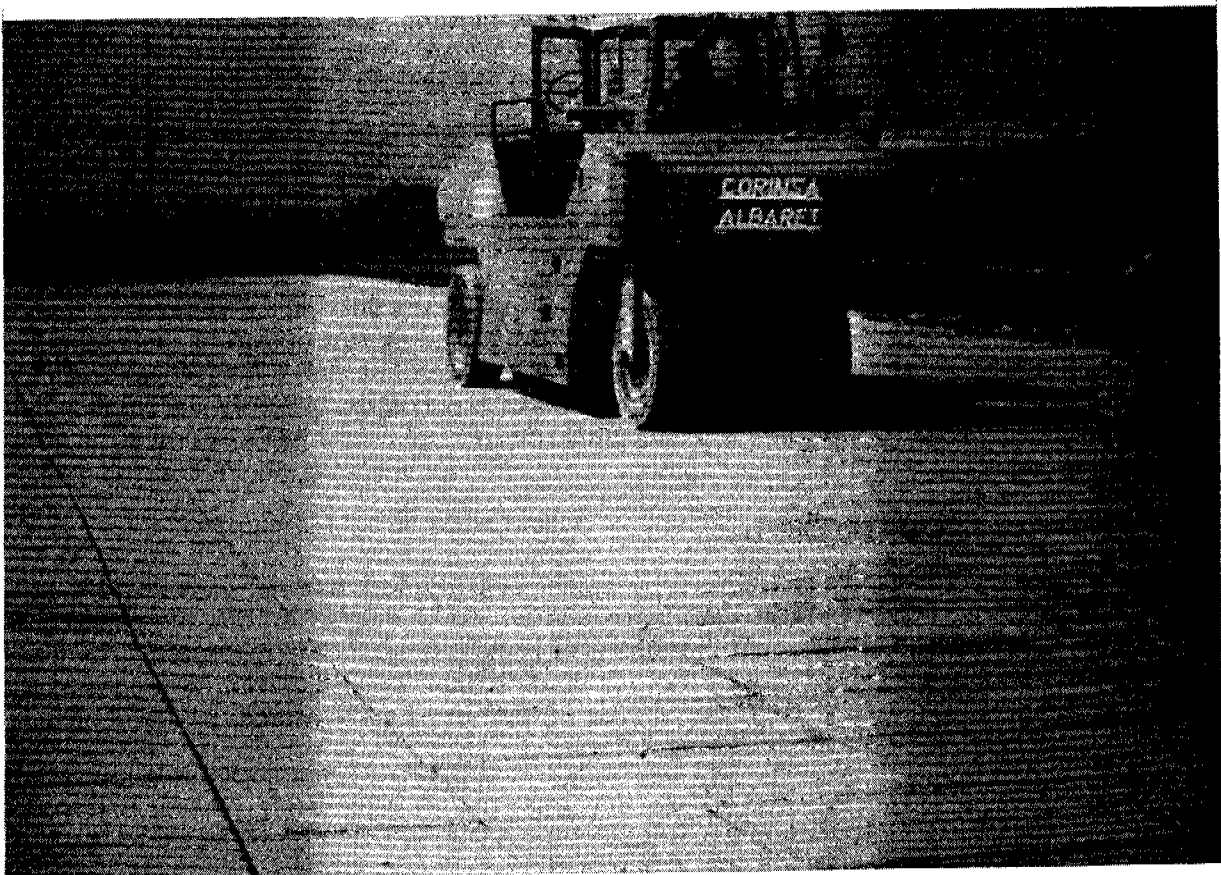

Figure 15
Injecting sand with screw type drill



Figure 16
Vibrating roller to settle semi-rigid floating pavement



- (a) High cost resulting from the large size of the units. The new units are 60 x 60 cm compared to 200 x 200 cm of the original precast concrete rafts and their weight is approximately 170 kg compared to 1300 kg i.e. a 1 to 11 reduction in surface area and a 1 to 7.6 reduction in weight.
- (b) Cracking across the corners as a result of the very large bending moments induced by the units being larger than the track width of handling equipment and subgrade settlement: this cracking is also compounded by the pumping action which takes place due to the penetration of water underneath the rafts. The horizontal dimensions of the new units (60 x 60 cm) are approximately the same or very near to the contact area of the wheels of most conventional container handling equipment, and therefore the units are mainly subjected to direct pressure rather than bending. This pressure is transmitted directly to the sandy subgrade which is mostly confined within the cavity of the units, hence the risk of losing the sand side-ways is minimised, and therefore the bearing surface is always guaranteed. Furthermore the presence of rubber joints between all units makes this pavement system waterproof.
- (c) Differential settlement occurs between rafts. The new units are joined together with a rubber joint keeping the adjacent units permanently together thus eliminating the possibility of any differential settlement between units.

40. The advantages of the semi-rigid floating rafts are:

- Good quality control in manufacture;
- Full strength achieved in off-site curing;
- Little plant needed for laying;
- Immediately operational;
- Capacity to deform;
- Possible to recover required levels without dismantling the pavement;
- Facilitates dismantling and rebuilding for installation of underground services;
- Simple maintenance;
- Elimination of provisional pavements over newly reclaimed areas or areas subject to large settlements.

The engineers who have developed and tested this system claim that the cost is comparable to other options.

41. From the above it is evident that this newly developed heavy duty pavement system is very promising. It is, however, felt by the authors that before including this option in their table on suitability of pavements for different operations taking into account cost effectiveness and performance (see section F of this chapter) more information is required, mainly on costs which will only be available after its adoption in some ports, not just on a trial basis but on a full scale basis.

E. Roller compacted concrete pavements

42. Roller compacted concrete (RCC) is a pavement construction material derived from zero slump concrete originally used in large dam construction. As the name implies, the concrete is compacted by roller as for conventional granular and cement treated base materials. The principal difference between RCC and those other materials is that its surface can be used directly as a running surface. Essentially, RCC has similar properties to conventional portland cement pavement quality concrete with the following differences.

- (a) Zero-slump concrete. This means that immediately after being placed, it is sufficiently stiff to support compaction equipment but sufficiently workable to respond to the compactive effort of that equipment.

- (b) Strength. RCC must develop sufficient strength so that it can be used as the major structural component of a pavement. This means that the minimum 28-day compressive strength should be approximately 30 N/mm^2 . Sometimes, particularly in North America, flexural strength is used as a criterion and a value of 3 N/mm^2 is often specified.
- (c) Durability. Unlike conventional pavement quality concrete, RCC cannot be air entrained. However, the construction procedure appears to leave sufficient air pockets to ensure that RCC is frost resistant. Experience in North America indicates that RCC can perform satisfactorily under moderate freeze/thaw conditions.
- (d) Materials. The stability of fresh RCC during compaction is related to the grading of the aggregate. Well graded aggregates similar to those used in bituminous materials have been found to be the most suitable. A typical maximum aggregate size of 20mm is used and suitable aggregates normally contain a higher proportion of material passing the 75 micron sieve than is found in conventional portland cement concrete aggregates. Non-plastic fines of between 5 and 10 per cent are considered acceptable. This fine material can be beneficial in that it acts as a mineral filler, so helping to produce a tighter surface texture. Not only does this provide additional surface durability but it can reduce the amount of cement added. In the case of 2 layer construction, the lower layer can have a maximum aggregate size of 40mm but this may lead to a little segregation.

43. Several structural design methods have been developed specifically for RCC in the United States. The Portland Cement Association (PCA) has developed a design procedure based upon fatigue and the achievement of design stresses. This design method is available from PCA at 5420 Old Orchard Road, Skokie, Illinois 60077, USA. Alternatively, the BPF manual can be used to design RCC pavements. The rigid concrete pavement charts should be used for this. The reason that those charts can be used is that the flexural strain capacity of RCC is similar to that for pavement quality concrete.

F. Revised table on suitability of pavements

44. The available choices for a container terminal pavement which have been described in both the original Monograph and this Supplement are listed below:

- (a) Bituminous or asphalt surfacing;
- (b) Conventional in situ concrete;
- (c) Precast concrete rafts;
- (d) Concrete paving blocks;
- (e) Gravel beds;
- (f) Steel fibrous in situ concrete;
- (g) Semi-rigid floating pavement;
- (h) Roller compacted concrete;
- (i) Conjunctive (composite) systems.

45. Table 2 in the original Monograph shows the suitability of pavements for different operations, taking into account cost effectiveness and performance. As a result of further experience gained by the authors, either personal or from the study of case histories, and due to the introduction of new developments in the field of port pavements, this table has been revised. The table, presented below, must be considered in conjunction with all the material presented in the original monograph, and particularly the comments made in paragraphs 27 to 34. Moreover, the following additional points in relation to the revised table have to be taken into consideration

46. As in the original table, pavement types described as "conjunctive systems" are not included because, as pointed out in paragraphs 85 to 89 of the original monograph, the potential forms that pavements in this category can take are unlimited and there is no practical

way to review such systems within the framework of a tabular format. For the reasons given in paragraph 39 the precast concrete rafts have also been dropped from the table.

47. Two of the new port pavement developments, namely, "roller compacted concrete" and "semi-rigid floating pavement", have not been included in the revised table for the following reasons. Despite technical evidence which suggests both of the above mentioned pavement types offer potential, these types have not as yet been so extensively used in container terminals with regard to both number of applications and years of experience. Thus their limited application to date does not enable the authors to assess them comprehensively with regard to their cost effectiveness and performance in worldwide application. This statement, however, should not discourage port engineers from considering these two pavement systems as possible options. It is expected that after a few years of further experience with these two systems, they will be included in the table.

CORRIGENDUM

Replace Revised Table, page 23, by the following table as the two numbers marked by asterisks were reversed:

Revised Table

*Suitability of Pavements for Different Operations
Taking into Account Cost Effectiveness and Performance*

Key: 1 = avoid if possible 5 = reasonable solution 10 = recommended solution

Type of operation	Asphalt	Conventional in situ concrete slabs	In situ steel fibrous concrete	Concrete paving blocks	Gravel beds
Container stacking	1	3	6	7	10
Trailer parking areas	2	7	7	7	-
Straddle carrier running lanes between containers	1	5	7	7	-
Straddle carrier marshalling areas	4	6	7	7	-
Fork lift truck marshalling areas	2 *	6	6	6	-
Highway vehicle marshalling areas	8 *	6	8	8	-
Mobile crane working areas	2	7	8	5	-
Yard Stacking cranes	1	3	4	4	10
Maintenance areas	1	8	10	5	-

Note: To use this table please refer to paragraphs 14 to 34 in Monograph No. 5 and paragraphs 44 to 48 of this Supplement.

Chapter III

NEW MAINTENANCE, REHABILITATION AND UPGRADING METHODS

A. Rapid repair material for pavements

48. Pavements in general, but particularly port pavements, due to the very harsh loading that they are subjected to, suffer extensively from surface damages (see figure 17). More often than not, small size potholes, cracks, depressions, spalls, broken areas and joints in asphalt and concrete surfaces, are overlooked or even ignored without realizing the potential consequences. The forks of fork-lift trucks, container corner castings, trailer dolly wheels, stabilizing jacks of mobile cranes, dynamic loading from container handling equipment, impact loading from mishandled cargo, sharp edges of some cargo or its packaging are only some of the common causes of the above mentioned surface damages in ports.

49. Such surface damages, though usually superficial and small in size, if not attended to immediately and comprehensively, may lead to severe and even total structural failures of pavements, eventually requiring costly maintenance and causing serious disruptions to port operations. Moreover potholes have on many occasions become dangerous traps to moving traffic, and instrumental for causing mechanical damages to vehicles and cargo handling equipment and even serious accidents.

50. Consequently, a prudent authority should undertake remedial work in good time, as once deterioration of the surface commences, total unserviceability of the pavement is imminent and rapid degradation takes place over a short interval, particularly during severe weather.

51. From the above it is evident that there are two important incentives for the immediate repair of the previously mentioned surface defects and damages in port pavements. Firstly, to continuously maintain an even and smooth riding surface for the moving traffic to minimize the risk for accidents. Secondly, to avoid subsequent costly medium and large-scale maintenance works which will also cause serious disruptions to port operations.

52. Long-term experience reveals that unattended small surfaces of an area of just a few square centimeters, within a few months grew to large potholes of several square metres. However, in spite of the fact that port engineers are fully aware of the above consequences, the time consuming and costly mobilization of the necessary maintenance units for traditional materials (e.g. asphalt plants, jack hammers, compressors, trucks, rollers, concrete mixers, skilled labour force, etc.) which are disproportionate to the small size repairs required, played an inhibiting role for the proper execution of this type of preventative maintenance.

53. Fortunately, the above situation has not escaped the attention of the industry, which has during the last decade developed a very useful material which gives both a technically effective and an economical solution to the problem. This material is called Instant Road Repair (IRR) and does exactly what its name implies. In addition, IRR has been very successfully used to eliminate level differences caused by differential settlement between the pavement and other more rigid structures such as manholes.

54. Now that IRR is fully proved worldwide and, moreover, following the positive experience that one of the authors has had with the use of Emcol Instant Road Repair for over ten years at the ports of Limassol and Larnaca in Cyprus, it is believed that it is time to disseminate and share this experience with other "container terminal pavement managers".

55. The technical and other characteristics of IRR and the standard method of repair of potholes and other surface damages on both asphalt and concrete pavements at the ports in Cyprus are briefly described below. However, it must be pointed out that the experience which has been gained in Cyprus has been exclusively with Emcol Instant Road Repair and therefore the information given below may not be wholly or partially applicable to other types of IRR.

56. IRR is formulated for the immediate, permanent repair of potholes, depressions and broken areas in tar macadam, asphalt and concrete surfaces. Packed in 25 kg buckets or sacks with a storage life of 10 and 4 months respectively, IRR is ready for immediate use without heating, mixing, pre-treatment of repair areas (cutting out, use of tack coats, e.t.c.,) or additions to the product before or after application. The use of a roller is not necessary, the only equipment required being a broom and a shovel.

Figure 17
Typical surface damages to port pavements



Damage caused by forks of FLT

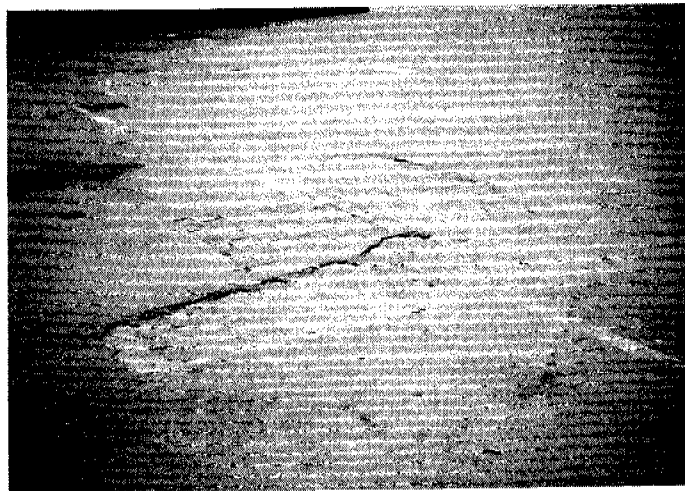

Damage around manhole cover



Damage from heavy container handling equipment

57. Unlike conventional materials, repairs with IRR can be made in extremes of heat (60°C) or cold (minus 40°C) and in snow/ice/heavy rain/wet conditions. Preparation of areas for repair is therefore, minimal. Ideally standing water/oil/debris is swept from the hole. In many instances where this has been proved impossible, however, repairs have always remained fully effective.

58. IRR is tipped from the pack into any size, shape or depth of hole to overfill and compacted with a back of a shovel or by use of a hand tamper if preferred. Repairs take an average of 3 minutes to complete and then immediately pedestrians or the heaviest traffic (i.e. container handling equipment) can cross repairs without pickup, marking of tyres or damage to repair (see figure 18). In the repair of deep holes, aggregates which must be well compacted, can be used to fill the cavity which is then topped with Instant Road Repair.

59. The product is formulated to remain flexible for some hours after completion of repair and curing takes place partly by air drying and partly by compaction. There is no depression of repair, no residue of loose stones, no contraction and the material abuts well to metal work, manholes, etc. (see figure 19).

60. Repairs monitored in areas of extreme weather variation and heavy continuous traffic have remained in situ for 10 years (so far) without deterioration. In the same area conventional repair materials break down in 24 hours and repairs have to be effected a few times per year.

61. Resistance of Instant Road Repair to fuel spillage is not claimed by the manufacturer but reports from several sources and the experience in Cyprus do indicate such resistance.

62. In making cost comparisons between IRR and conventional hot and cold patch materials, it is a mistake to simply compare tonne for tonne. It is necessary to make an overall comparison taking into account equipment involved (jack hammer, compressor, truck, roller, traffic lights), wastage of material, manhours, durability of repairs and traffic hold ups, disruption to port operations and the fact that in effect smaller areas will be required to be repaired. It has been shown that substantial savings can be achieved using Instant Road Repair in preference to conventional methods.

B. New generation geotextiles for overlay techniques

63. The demand worldwide for reduction of the immense repair costs of aged pavements has recently resulted in the deployment of the new technology of geotextiles in developing a very successful overlay technique using asphaltic pavements. Asphalt overlay for the prevention of reflective cracking in surfaces has now become a major application area for geotextiles.

64. Secondary crack formation or vertical crack propagation in the surface of an asphaltic pavement is not uncommon. These cracks usually result from flexural fatigue, natural ageing of the surface because of the many diverse environmental influences and due to a few other mechanisms. These cracks result in the loss of the sealing function of the surface course, thus, allowing the penetration of moisture and rainwater through the cracked surface in to the base course, causing a reduction in the shear strength of the base course material. The resulting damage is the formation of ruts, concentrated longitudinal cracks in the traffic lanes, potholes and frost damage.

65. If the cracked pavement surface is renovated by resurfacing, reflection cracking, i.e., crack propagation from the old to the new pavement surface, can lead to the formation of tertiary cracks in the new surface cover. These cracks are also caused by the combined influence of temperature and traffic stresses and also lead to the loss of the sealing effect of the bituminous surfacing, and thus to a further reduction of the shear strength of the base course material.

66. This has been the case in the ports of Larnaca and Limassol in Cyprus, for which one of the authors is responsible for maintenance and construction, where for many years, the common resurfacing of aged asphaltic pavements proved to be only a temporary measure, as the crack patterns of the old surfaces were reappearing on the new surfaces within a period of a few months, usually following a climatic seasonal change (see figure 20a). However, since the introduction of a geotextile membrane in the overlay systems applied for the renovation of aged asphaltic pavements in both the above mentioned ports, the problem of reflection cracking has been solved (see figure 20b). In particular, in the cases mentioned above a polypropylene, non-woven, needlepunched, weldable, asphalt impregnated geotextile of the type polyfelt PGM14 was used as shown in figure 21 with excellent results.

Figure 18
Instant road repair procedure

1 Brush away loose debris or standing water /oil.

2 Slightly overfill entire area of hole



3 Compact with shovel or tamper.

4 Immediately ready for use by the heaviest traffic

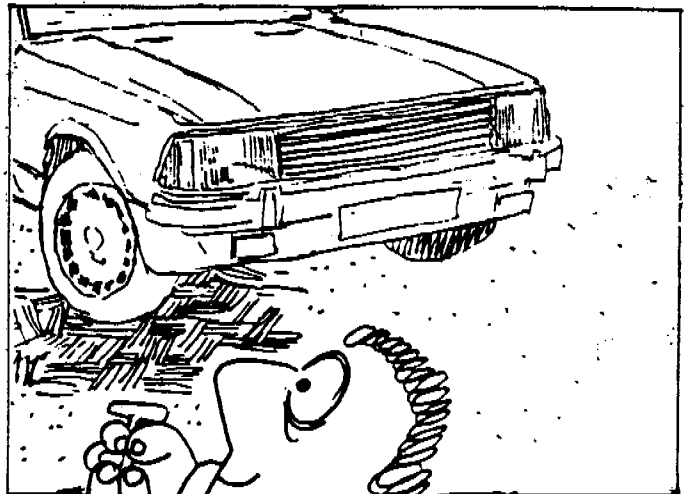
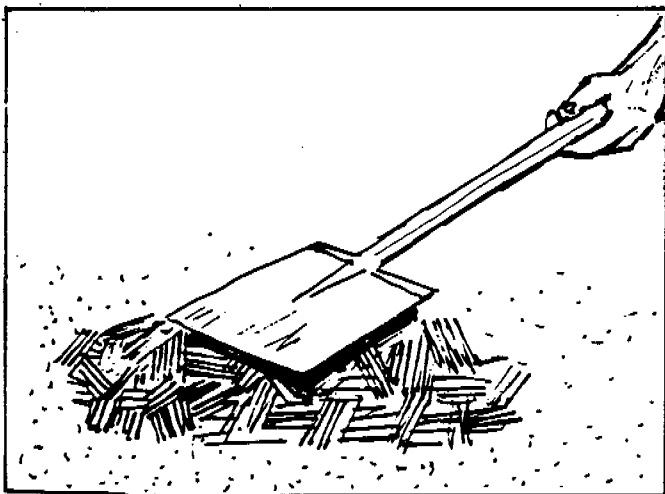
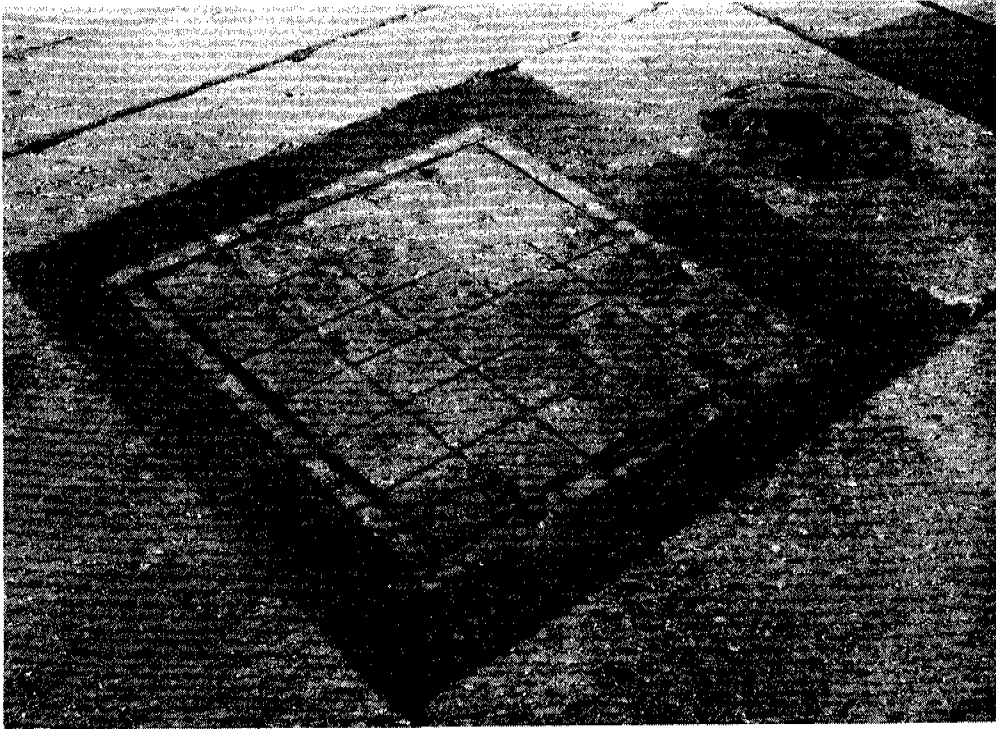
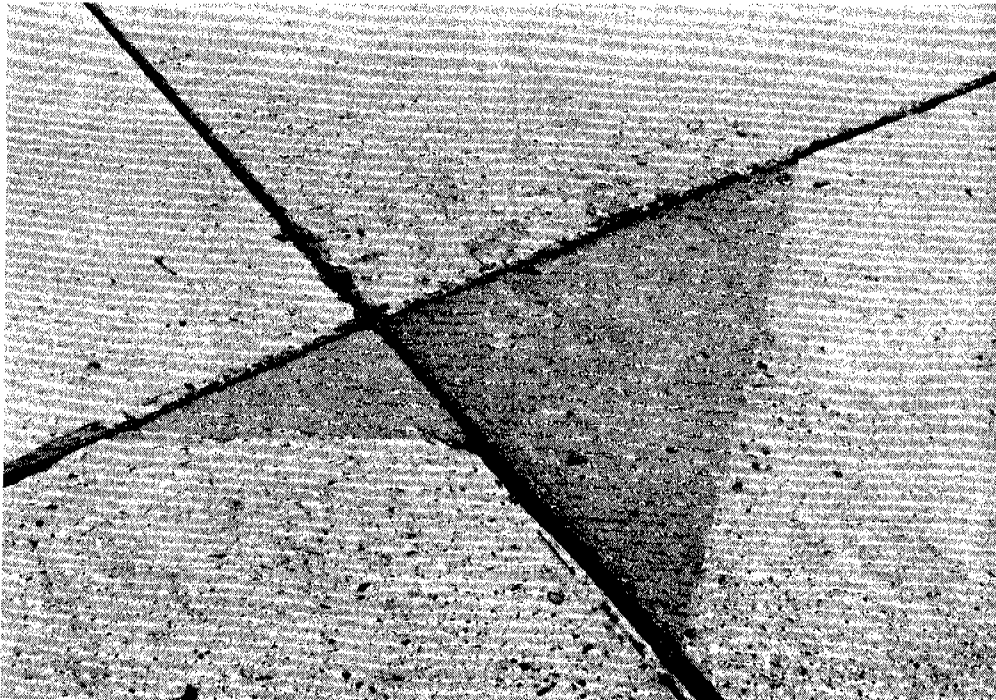

Figure 19
Examples of repairs made with IRR



Asphalt pavement around manhole covers



Concrete pavement corners

Figure 20
Examples of surfacing life in Larnaca port

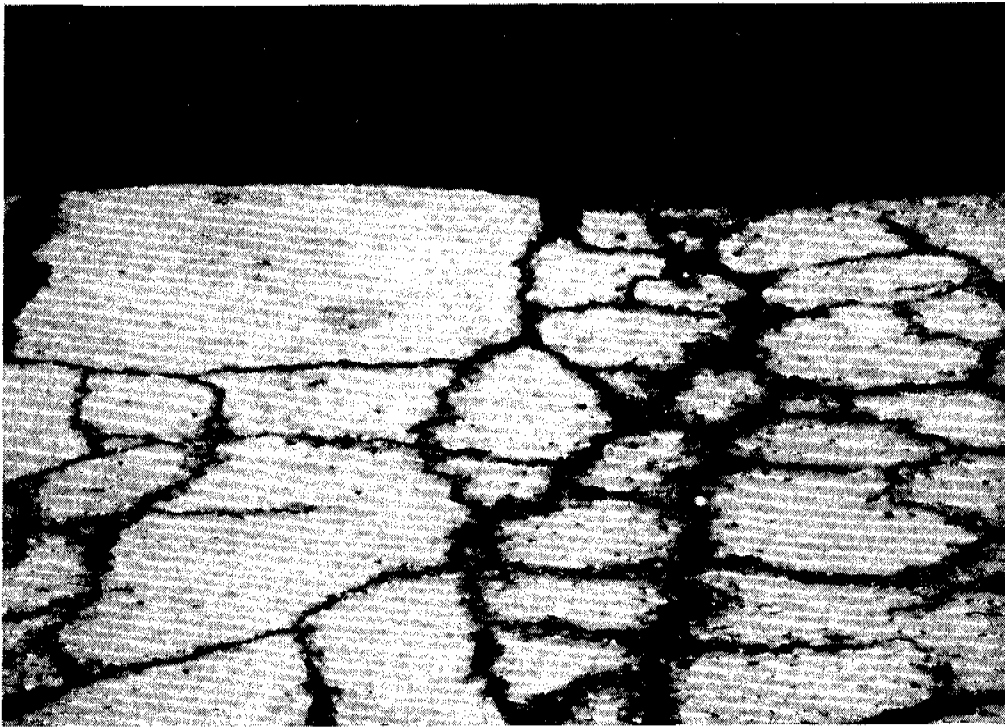

(a) Six months after resurfacing without using geotextiles

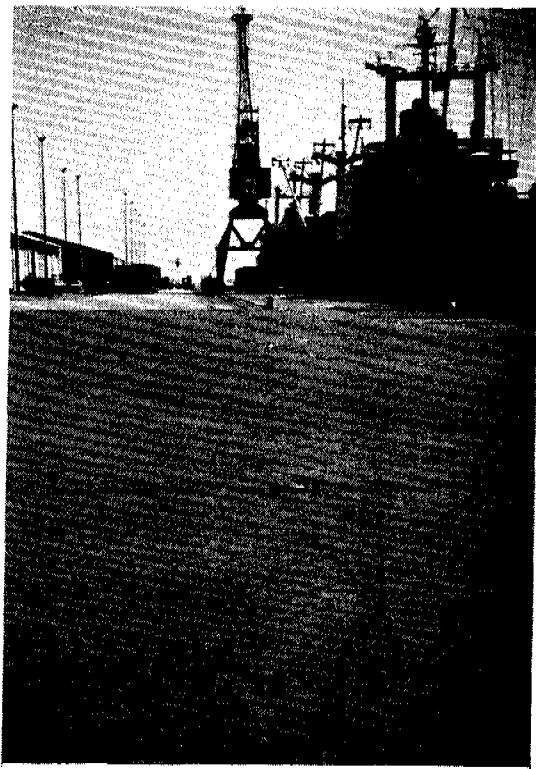

(b) Four years after resurfacing using a geotextile membrane

Figure 21
Two methods of applying asphalt overlays used at the
ports of Limassol and Larnaca

METHOD 1

FOR CRACKED AND WEATHERED ASPHALT CONCRETE PAVEMENT

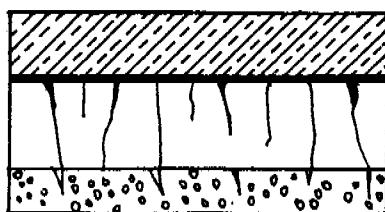

NEW PAVEMENT
POLYFELT PGM 14
OLD PAVEMENT
SUBGRADE

METHOD 2

FOR SEVERELY CRACKED AND FAULTED ASPHALT CONCRETE PAVEMENT.

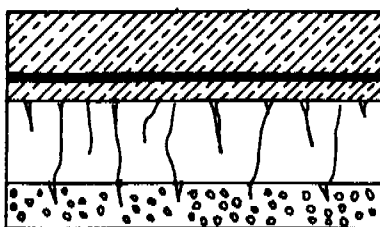

NEW PAVEMENT
POLYFELT PGM 14
LEVelling COURSE
OLD PAVEMENT
SUBGRADE

67. This type of geotextile, which is very simple to use (see figure 22), when used to prevent reflective cracking in asphalt overlay, fulfills two main functions: sealing or water proofing and reinforcing. The sealing feature of the asphalt impregnated geotextile polyfelt PGM14, as well as the increased resistance to flexural fatigue of the new asphalt overlays at the ports of Larnaca and Limassol, are considered to be the determining influence factors for extending the life of the existing asphaltic pavement in these ports. An observation period of more than 12 years in field testing in other cases leads to an empirical value for the increase in pavement life factor ranging between 2 and 3.

Figure 22
Application of geotextile membrane after spraying surface
with tack coat



Chapter IV

REVISED BPF PORT PAVEMENT DESIGN MANUAL

A. Introduction

68. The second edition of the British Ports Federation Manual was published in 1989 after the 1984 edition sold out. The opportunity was taken to revise the layout of the pavement design charts and to introduce several technical changes. Before outlining these revisions and changes it is important to amplify the following statement made in the *Foreword* of the 1989 edition of the BPF Manual: "The United Nations publication *Container Terminal Pavement Management* forms a complementary companion to this Manual".

B. Revised presentation of design charts

69. The principal aim in revision of the presentation of the design charts was to reduce the size of the Manual without sacrificing accuracy. This has been achieved in four ways. Firstly, the two permissible strain graphs have been removed from each chart and placed as two separate charts at the front of the main body of charts. This has reduced the size of the Manual by a factor of 3.

70. Secondly, the charts have been printed on both sides of the paper, so reducing size by a factor of 2. Thirdly, charts for subgrade California Bearing Ratio's (CBR's) of 2 per cent, 4 per cent, 6 per cent, 7 per cent, 15 per cent and 20 per cent have been eliminated, leaving only 1 per cent, 3 per cent, 5 per cent, 10 per cent and 30 per cent. Experience has shown that this will lead to no appreciable error and the saving in size is greater than two. Fourthly, the 150mm thickness sub-base charts have been eliminated so saving 25 per cent. Together, all of these changes have resulted in a sixteenfold reduction in the thickness of the Manual so that it is now published in A4 paperback format. A secondary benefit is a substantial reduction in price.

C. Technical changes

71. The technical changes introduced in the second edition of the BPF Manual are, firstly, that design charts for fully flexible pavements with granular bases are included. This was done as the Manual is now being introduced to the United States where fully flexible industrial pavements are common. For the design of granular bases a new chart (see figure 23) has been included which shows the relationship between permissible vertical compressive strain and number of load repetitions for a granular base. This chart shows, for example, that a granular base subjected to 1,000,000 repetitions must not be allowed to attain a vertical compressive strain greater than 450 microstrain (0.00045 strain). The design procedure is identical to that for cement stabilized bases (lean concrete) and rigid concrete slabs i.e the appropriate LCI (Load Classification Index) and base thickness charts are used to read off the corresponding values for each case. For reading off the required granular base thickness value on the relevant chart a special horizontal line has been included which corresponds to the granular material elastic modulus which is taken as 1000 N/mm². The Manual recommends that when a granular base is used, its CBR should not be less than 80 per cent.

72. The second change was also introduced as a result of the needs of the USA and includes imperial units alongside the metric system. The Manual is being introduced to the USA by the American Association of Port Authorities.

73. A third change is a revised method of calculating wheel proximity factors for plant which has wheels side by side such that the stresses generated by one wheel interact with those generated by another. A technique is used in the Manual whereby the critical stress directly beneath a wheel can be increased to take into account the stress contributed by a nearby wheel. In the 1984 Manual this was achieved by introducing a Wheel Proximity Factor, which is a factor by which a single wheel load is multiplied to account for its neighbours. The amount which a neighbouring wheel contributes depends not just on the size of the load and closeness of the wheel, but also on the thickness of the pavement being designed - this is because the critical interaction point is near the underside of the pavement. The revised Manual takes pavement thickness into account for the first time and so allows wheel proximity to be evaluated more precisely.

Figure 23
Permissible compressive strain for granular bases

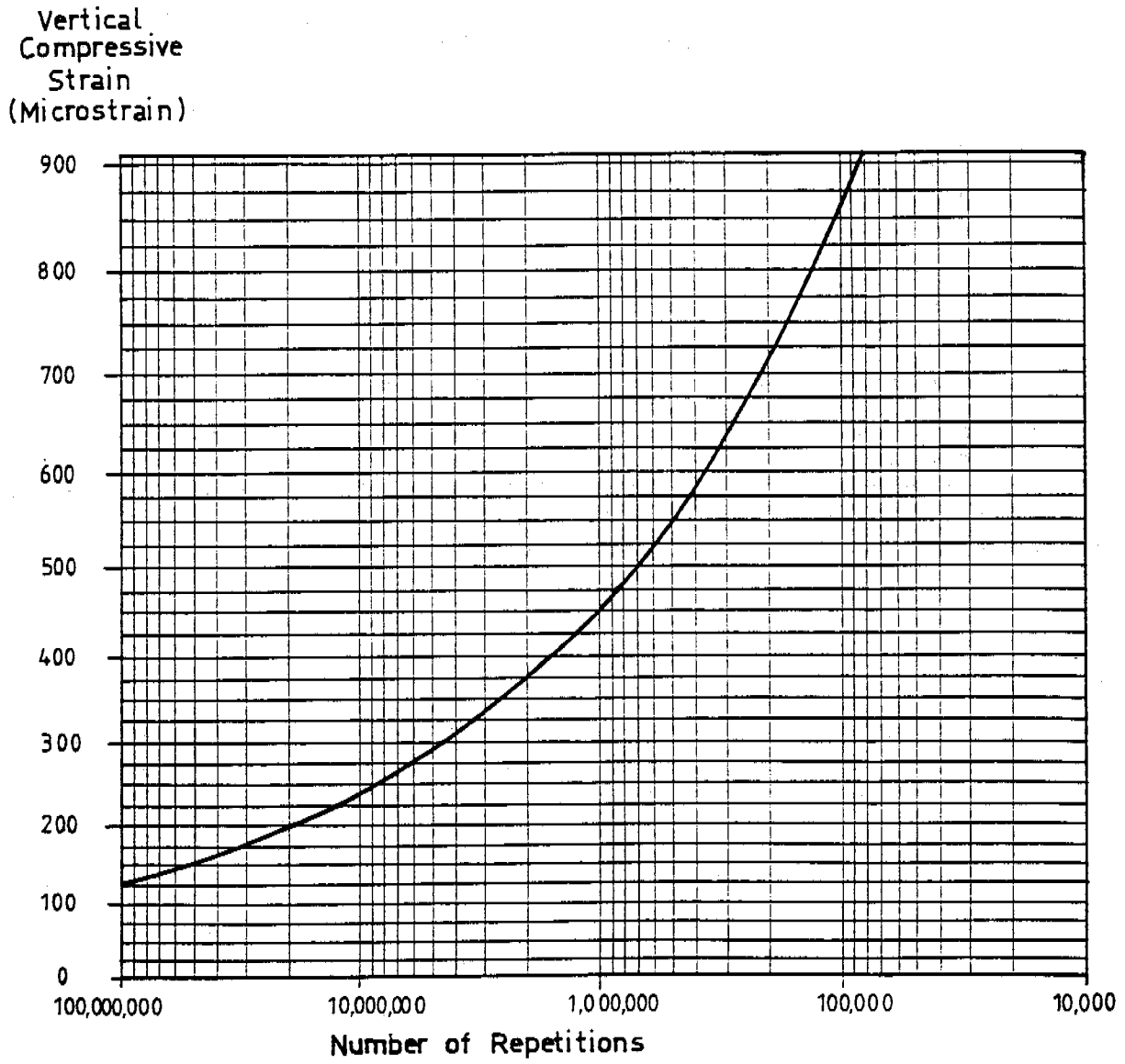

74. Firstly, the final thickness of the pavement must be estimated prior to design. The following equation provides an approximate value for the effective depth of the pavement from its surface to the underside of the base. The effective depth is that depth of subgrade material which would spread the load in a similar manner to the actual pavement construction being designed. The equation takes the following form:

$$\text{Effective depth} = 300 \sqrt[3]{\frac{3,500}{\text{CBR} \times 10}}$$

75. Once this value has been obtained, the Proximity Factor can be read from the following table.

Wheel Spacing (mm)	Proximity Factor for Effective Depth of:		
	1,000mm	2,000mm	3,000mm
300	1.82	1.95	1.98
600	1.47	1.82	1.91
900	1.19	1.65	1.82
1,200	1.02	1.47	1.71
1,800	1.00	1.19	1.47
2,400	1.00	1.02	1.27
3,600	1.00	1.00	1.02
4,800	1.00	1.00	1.00

Intermediate values may be obtained by interpolation, both down and across the table.

76. For example, suppose a fork lift truck had three wheels at one end of its front axle. The critical position would be directly beneath the middle wheel. If the wheel spacing were 600mm and the effective depth had been calculated to be 2000mm, then the factor would be 1.82 which would be applied for each of the two side wheels. Suppose each of the three wheel loads were 10,000 kg, the single equivalent wheel load would be:

$$10,000 + 8,200 + 8,200 \text{ kg} = 26,400 \text{ kg}$$

Note that this is 12 per cent less than if all of the load had been transmitted through one wheel.

77. A fourth change is the introduction of a new composite material for the design and construction of port pavements, the steel fibrous concrete, which has been described in chapter II section C of this document. By increasing the tensile strain capacity of rigid concrete whilst maintaining the elastic modulus constant, fibres allow thinner slabs to be provided. Just as Chart C of the Manual (see figure 23) allows the user to determine the limiting strain for granular bases, so Chart B of the Manual (see figure 24) shows allowable radial tensile strain in microstrain for both conventional concrete and for fibre reinforced concrete. It applies to galvanized steel fibres with a tensile strength of at least 1000 N/mm² and with anchors at the ends of the fibres to prevent debonding. Following information from some testing by the manufacturers of such fibres, the Manual assumes that the radial tensile strain can be increased by a factor of 1.75. However, as is pointed out in chapter 1.8.4.3 of the Manual, "In all cases, fibre reinforced concrete should be discussed with the consulting engineer or fibre manufacturer".

78. This is because there are so many variables (e.g. material, size, shape, dosage of fibres, etc.) which make it impossible to standardize the design parameters and use a single chart. Therefore port pavement designers should be aware of the fact that there are cases where steel fibrous concrete will show superior or inferior performance (i.e. will result in thinner or thicker slabs) than that implied by the strain chart included in the Manual (see figure 24). It is emphasized that in comparing two pavement designs, i.e. one with conventional concrete and one with steel fibre concrete, not only should the pavement thickness difference be considered, but also all the additional advantages (e.g. increased toughness, impact resistance, ductility, etc.) of steel fibrous concrete which are described in chapter II section 3 of this document.

Figure 24
Permissible tensile strain for rigid concrete slabs

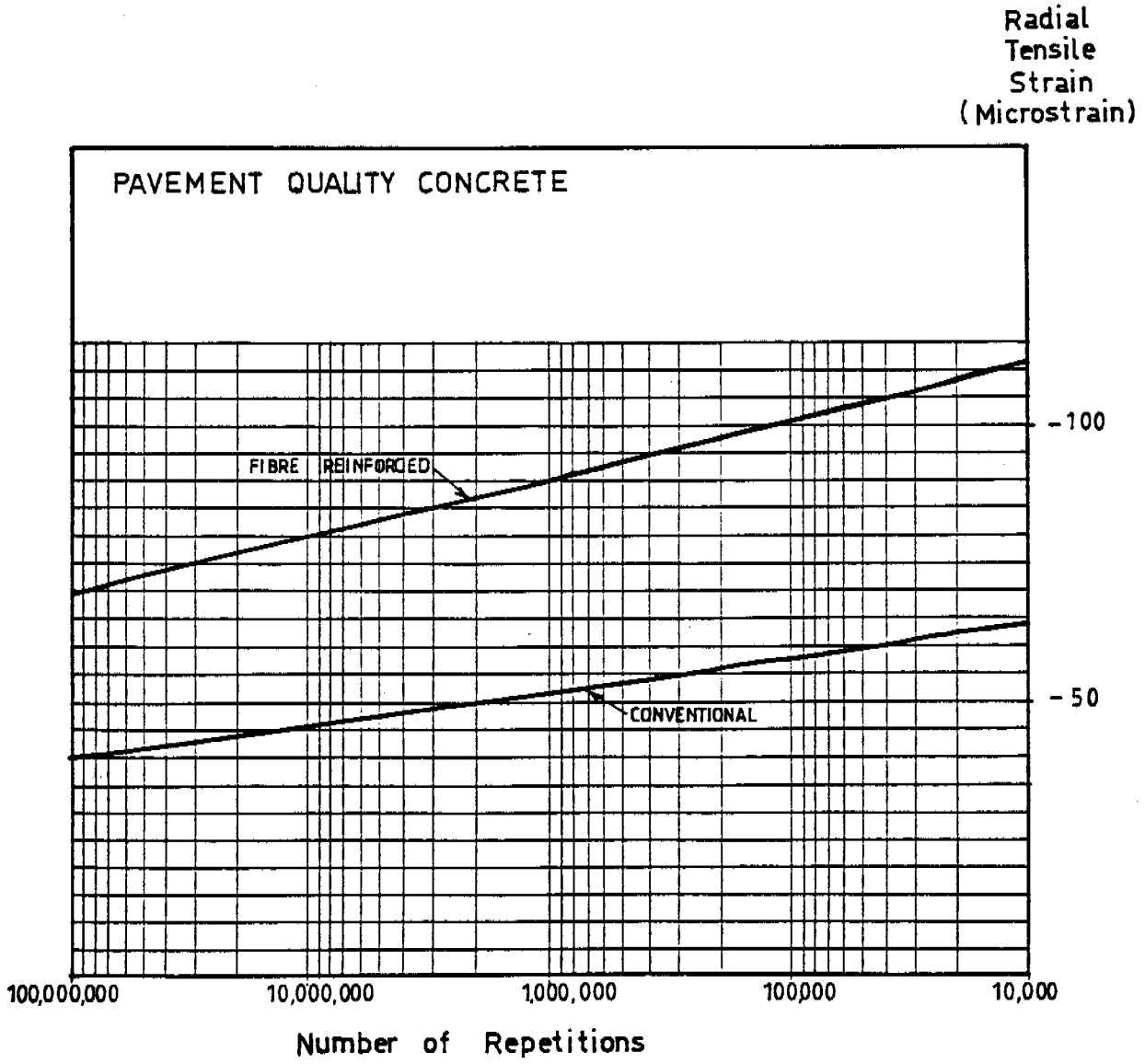

79. Finally, a simplified Load Classification Index (LCI) system is introduced which reduces the number of calculations required to categorize the damage inflicted by plant on pavements. Perhaps this simplification of the procedure for assessing the damaging effect of plant is the most important revision of all. Over the last few years, experience has shown that handling equipment is at its most damaging when it handles containers of weight 20,000kg, 21,000kg, 22,000kg or 23,000kg - remember that most damage is inflicted by a combination of weight and number of repetitions so that an occasional container heavier than 23,000kg inflicts less damage to a pavement than many containers with the four values shown. This is illustrated by an example which is presented in chapter 3.1 of the Manual.

كيفية الحصول على منشورات الأمم المتحدة

يمكن الحصول على منشورات الأمم المتحدة من المكتبات ودور التوزيع في جميع أنحاء العالم. استعلم عنها من المكتبة التي تتعامل معها أو اكتب إلى : الأمم المتحدة، قسم البيع في نيويورك أو في جنيف.

如何购取联合国出版物

联合国出版物在全世界各地的书店和经售处均有发售。请向书店询问或写信到纽约或日内瓦的联合国销售组。

HOW TO OBTAIN UNITED NATIONS PUBLICATIONS

United Nations publications may be obtained from bookstores and distributors throughout the world. Consult your bookstore or write to: United Nations, Sales Section, New York or Geneva.

COMMENT SE PROCURER LES PUBLICATIONS DES NATIONS UNIES

Les publications des Nations Unies sont en vente dans les librairies et les agences dépositaires du monde entier. Informez-vous auprès de votre libraire ou adressez-vous à : Nations Unies, Section des ventes, New York ou Genève.

КАК ПОЛУЧИТЬ ИЗДАНИЯ ОРГАНИЗАЦИИ ОБЪЕДИНЕННЫХ НАЦИЙ

Издания Организации Объединенных Наций можно купить в книжных магазинах и агентствах во всех районах мира. Наводите справки об изданиях в вашем книжном магазине или пишите по адресу: Организация Объединенных Наций, Секция по продаже изданий, Нью-Йорк или Женева.

CÓMO CONSEGUIR PUBLICACIONES DE LAS NACIONES UNIDAS

Las publicaciones de las Naciones Unidas están en venta en librerías y casas distribuidoras en todas partes del mundo. Consulte a su librero o diríjase a: Naciones Unidas, Sección de Ventas, Nueva York o Ginebra.
