



**Economic and Social
Council**

Distr.
GENERAL

TRANS/SC.3/2004/1
25 November 2003

ENGLISH
Original: ENGLISH, FRENCH
AND RUSSIAN

ECONOMIC COMMISSION FOR EUROPE
INLAND TRANSPORT COMMITTEE

Working Party on Inland Water Transport
(Forty-eighth session, 19 – 21 October 2004,
agenda item 7(a))

**AMENDMENT OF THE RECOMMENDATIONS ON
TECHNICAL REQUIREMENTS FOR INLAND NAVIGATION VESSELS
(annex to resolution No. 17, revised)**

Note by the secretariat

The Working Party on Inland Water Transport, at its forty-seventh session, requested the secretariat to issue a consolidated text of the amended chapters of the annex to resolution No.17, revised, provisionally approved by this Working Party, with a view to facilitating their finalization by Governments and the Group of Volunteers (TRANS/SC.3/161, para. 37).

The consolidated text of the draft amended chapters 2-7, 9, 10A, 10B, 11, 11*bis* and 12-14 of the annex as provisionally approved by the Working Party to date is reproduced below. This document comprises the texts reproduced in TRANS/SC.3/2000/1 and Adds.1-3, TRANS/SC.3/2000/1/Corrs.1-3 and TRANS/SC.3/2000/1/Add.1/Corr.1.

CHAPTER 2

HULL

2-1 STRENGTH

2-1.1 The general structural strength of the hull shall be sufficient to withstand all stresses under normal conditions of operations.

2-1.2 The structure of the hull, superstructures, deckhouses, machinery casings, companionways, hatchways and their closures, etc., and the equipment shall be designed to withstand the normal conditions of operation to the satisfaction of the Administration. The Administration may consider this requirement met by a vessel built and maintained in conformity with the rules of a recognized Classification Society.

However the minimum thickness for bottom and side plating shall never be less than 3 mm.

2-2 STRUCTURAL REQUIREMENTS

2-2.1 Layout of decks

The working areas on decks and on deckways shall be large enough to allow the crew to move about and work safely.

2-2.2 Openings in decks

All removable covers shall be protected against accidental shifting. Access openings shall be such as not to interfere with safe movement without prejudice to the requirements of other safety regulations and, in particular, those of chapter 3, the coamings shall be as low as possible. There shall be no possibility of covers and doors closing accidentally.

2-2.3 Hatchways

2-2.3.1 Construction of hatchways

Cargo hatchways shall be surrounded on all sides by coamings. It shall be made impossible for loading tackle to catch on the lower edges of hold coamings.

2-2.3.2 Hatch covers

Hatch covers must be capable of bearing the expected load. Non-load-supporting hatch covers shall be marked as such. If hatch covers admit walking, they must be able to withstand not less than 75 kg of concentrated load. Hatch covers intended to receive deck cargo shall be designed accordingly and have the permissible load in t/m² marked on them.

Hatch covers and their supporting beams shall be so designed that they cannot be shifted accidentally by the wind, by tackle used for loading or moving the vessel, etc.

The hatch covers and all their components (e.g. fore-and-afters) shall be safe to handle.

CHAPTER 3

FREEBOARD AND SAFETY DISTANCE

3-1 GENERAL

3-1.1 This chapter specifies the minimum freeboard for inland waterway vessels. It also contains requirements concerning the indication of the freeboard mark.

3-1.2 This chapter assumes that the nature and stowage of the cargo, ballast, etc., are such as to ensure adequate stability and as to obviate any excessive structural fatigue.

3-1.3 Freeboards as prescribed in this chapter shall be assigned on the assumption, first, that navigation will cease when weather conditions are such that the maximum wave height defining the zone or zones in which a vessel is to navigate may be exceeded, and second that in such conditions vessels already under way will seek shelter as quickly as possible.

3-1.4 The Administration may consider it sufficient if the vessel has been built and maintained in conformity with the rules of a recognised Classification Society.

3-2 TYPES OF VESSELS

For the purpose of this chapter, vessels shall be divided into three types:

Type A - Decked vessels

Type B - Tankers

Type C - Open vessels

Type A: Decked vessels. Decked vessels are vessels whose hatch covers are satisfactorily strong, rigid, sprayproof or weathertight.

Type B: Tankers and similar vessels. These vessels have only small openings giving access to the tanks, the openings being closed by steel or equivalent covers with watertight fittings. Such vessels have the following characteristics:

- (i) Very high watertight integrity of the exposed deck;
- (ii) Very high resistance to flooding, through low permeability of the loaded compartments and through the degree of subdivision applied in general.

Type C: Open vessels. Open vessels are either vessels whose hatch covers are not satisfactorily strong, rigid, sprayproof or weathertight or vessels whose cargo hatchways are open.

3-3 APPLICATION AND DEROGATIONS

3-3.1 The maximum draught level shall be so determined that both the freeboard requirements and the safety-distance requirements are observed. For safety reasons, however, the Administration may prescribe a higher figure for the freeboard.

3-3.2 Vessels so constructed that application of the provisions of this chapter is unwarranted or impracticable shall be assigned freeboards by the Administration in such a way that the safety conditions are equivalent to those of this chapter.

3-3.3 In the case of zone 1, derogations from the conditions of assignment of freeboard may be allowed to vessels to which a freeboard in excess of the minimum freeboard is assigned, provided that the safety conditions are deemed satisfactory by the Administration.

3-4 DETERMINATION OF FREEBOARDS

3-4.1 General

3-4.1.1 Definitions of terms used

Length

The length (L) shall be taken as 96% of the total length on a waterline at 85% of the minimum moulded depth measured from the top of the keel, or as the distance between the foreside of the stem and the axis of the rudder stock on that waterline, whichever is the greater. In vessels with a designed trim, the waterline on which this length is measured shall be parallel to the design load waterline.

Perpendiculars

The forward and after perpendiculars shall be taken at the ends of the length (L). The forward perpendicular shall pass through the point of intersection of the foreside of the stem with the waterline on which the length is measured.

Amidships

Amidships is at the middle of the length (L).

Breadth

The breadth (B) is the maximum breadth measured to the moulded line of the frames in vessels with a metal shell and to the outer surface of the hull in vessels with a shell of any other material.

Moulded depth

The moulded depth (D) is the vertical distance measured from the top of the horizontal keel to the top of the freeboard deck beam amidships at the vessel's side.

Safety distance

The safety distance is the vertical distance measured between the maximum draught level and the lowest point above which, disregarding water intakes and outlets, the vessel can not be deemed watertight.

Freeboard

The assigned freeboard is the vertical distance measured amidships between the upper edge of the deck line as defined in paragraph 3-4.1.2 and the maximum draught level.

Freeboard deck

The deck from which the freeboard is measured shall normally be the uppermost complete deck exposed to the weather, up to which the watertight bulkheads of the hull extend and below which all openings in the ship's sides are fitted with permanent watertight closures.

In vessels having a discontinuous freeboard deck, the lowest part of the exposed deck and the continuation of that deck parallel to the upper part of the deck shall be taken as the freeboard deck.

Superstructure

A superstructure is a decked structure on the freeboard deck which extends from side to side of the vessel or whose side walls are not set inboard of the ship's sides by more than 4% of the breadth (B).

An enclosed superstructure is a superstructure:

Having closed bulkheads of sufficient strength, permanently so assembled with the deck as to be watertight;

In which the access openings, if any, in these bulkheads are fitted with watertight doors;

In which all other openings in the sides or ends are fitted with watertight closures.

The height of a superstructure is the mean vertical distance measured at the sides from the top of the freeboard deck beams to the top of the superstructure deck beams.

The length of a superstructure is the mean length of that part of the superstructure which lies within the length (L).

If the superstructure is set in from the ship's plating, the length shall be multiplied by the ratio of the breadth of the superstructure at the middle of its length to the breadth of the ship at the middle of the length of the superstructure.

A forecastle and a poop are superstructures which extend to the forward and the after perpendicular, respectively.

Watertight

Structural components or devices shall be deemed watertight if they are so fitted as to prevent any ingress of water into the vessel when they are subjected to a pressure corresponding to a head of water of one metre for one minute, or to a jet of water at a pressure of not less than 100 kPa (1 bar) for 10 minutes, in all directions over the entire surface of the structural component or device.

Weathertight

A device shall be deemed weathertight if, under all weather conditions encountered in the assigned zone, it prevents water from entering the vessel.

Sprayproof

A device shall be deemed sprayproof if, under all weather conditions encountered in the assigned zone, it allows only a small quantity of water to enter the vessel.

Flush-deck vessel

A flush-deck vessel is a vessel which has no superstructure on its freeboard deck.

3-4.1.2 Deck line

The deck line is the upper edge of a horizontal rectangle 300 mm long and 25 mm wide. This rectangle shall be marked amidships on each side of the hull, and its upper edge shall normally pass through the point where the continuation outwards of the upper surface of the freeboard deck intersects the outer surface of the shell amidships. However, the deck line may also be marked at a different height provided that the freeboard is corrected accordingly.

3-4.1.3 Freeboard mark

The freeboard mark for vessels for zone 3 consists of a horizontal band of 300 mm long and 40 mm width.

The freeboard mark for zone 1 and 2 shall consist of a ring intersected through its centre by a horizontal line which shall be supplemented if necessary by additional freeboard lines.

The width of the ring and of all the other lines of the freeboard mark shall be 30 mm; the outer diameter of the ring shall be 200 mm; the length of the horizontal line intersecting the ring shall be 300 mm; and the size of the numerals designating the zones shall be 60 x 40 mm (Figure 1).

The centre of the ring shall be placed amidships. The lower edge of the horizontal line which intersects the ring shall pass through the centre of the ring and shall constitute the freeboard line.

If the vessel is intended to navigate in several navigation zones, a vertical line and additional freeboard lines 150 mm in length shall be applied forward of the centre of the ring.

The lower edge of each freeboard line shall correspond to the freeboard prescribed for the navigation zone concerned.

If the vessel is measured in accordance with the Convention on the Measurement of Inland Navigation Vessels, it shall bear, in addition to the freeboard mark, a measurement mark in accordance with the requirements of this Convention.

The freeboard mark and the measurement mark may be combined. In this case, the width of the freeboard mark rectangle (the width of the upper line if there are a number of freeboard marks) should be 40 mm.

Figure 1

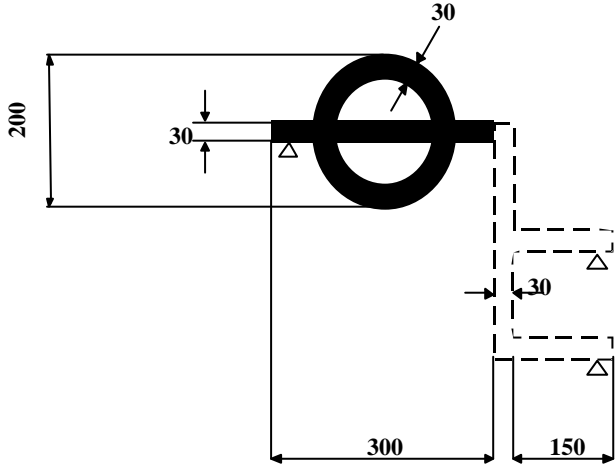

Zones 1 and 2

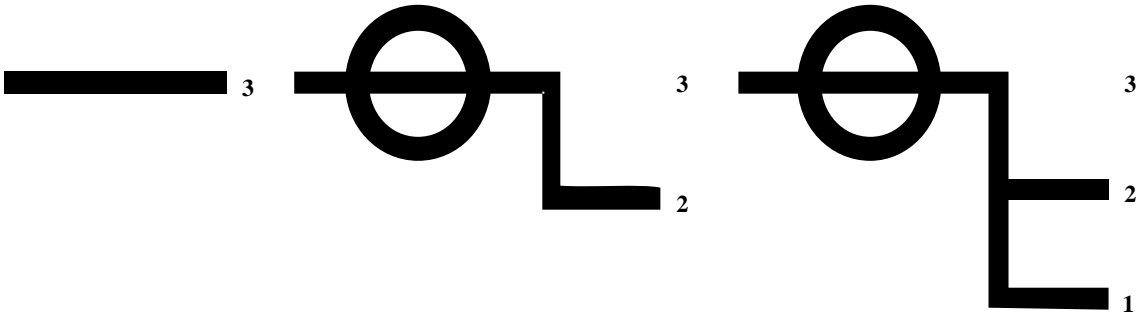

Zone 3

Zone 2

Zone 1

3-4.2 Minimum freeboard

3-4.2.1 Minimum freeboard (F) for vessels of type A

Length of the vessel m	Minimum freeboard (F) mm	
	Zone 1	Zone 2
≤ 30	250	250
40	340	300
50	440	340
60	570	340
70	570	340
≥ 80	570	340

Note: In this and all subsequent tables, the values for the intermediate lengths of vessels shall be obtained by linear interpolation.

3-4.2.2 Minimum freeboard (F) for vessels of type B

Length of the vessel m	Minimum freeboard (F) mm	
	Zone 1	Zone 2
≤ 30	180	160
40	250	220
50	330	220
60	420	220
70	420	220
≥ 80	420	220

3-4.2.3 The minimum freeboard of flush-deck vessels should be obtained in the manner indicated for the vessel of type B.

3-4.2.4 The minimum freeboard for vessels of type C, regardless of length, should be not less than:

for zone 1 - 1000 mm

zone 2 - 600 mm

Furthermore, the sum of the freeboard and the height of coamings for these vessels must be not less than:

for zone 1 - 1200 mm

zone 2 - 1000 mm.

3-4.2.5 The Administration may authorize corrections for the freeboard for vessels with poop, sheer and forecastle, providing that such corrections are calculated in conformity with the rules of the Administration or of a recognized Classification Society.

3-4.3 Arrangement of openings and coamings

3-4.3.1 All outside doors of superstructure, deckhouses and companionways, situated on the freeboard deck shall be watertight on vessels in zone 1 and sprayproof on vessels in zones 2 and 3.

3-4.3.2 The coamings of hatchways, companionways and access openings to superstructures shall be not less than 300 mm high on vessels in zone 1 and 150 mm on vessels in zone 2.

3-4.3.3 If the height of the coamings is less than that required by this chapter, the minimum freeboard height shall be increased by the difference between the height required in 3-4 3.2 and the actual height of the coamings.

3-4.3.4 The freeboard height may not be reduced owing to an increase in the height of coamings below the figure indicated in 3-4 3.2.

3-4.3.5 Exposed cargo hatchways and other hatchways on the freeboard deck shall be fitted with weather tight closures on vessels in zone 1 and sprayproof closures on vessels in zones 2 and 3.

3-4.3.6 Ventilator heads on the exposed parts of the freeboard deck shall be fitted with a strong steel coaming of a height not less than that required for hatchway coamings. Ventilator heads for vessels in zone 1 must have efficient closures.

3-4.3.7 Pipe outlets in the ship's sides below the freeboard deck shall be fitted with efficient and accessible devices to prevent water from entering the vessel.

3-4.3.8 On vessels in zone 1, side scuttles in spaces below the freeboard deck shall be watertight and be provided with permanently attached deadlights. Windows in superstructures, deckhouses and companionways and windows in skylights on the freeboard deck, however, need only be watertight. The distance between side scuttles in the shell and the maximum draught level shall not be less than 300 mm.

3-4.3.9 Skylights and windows must be of sturdy construction.

3-4.3.10 On vessels in zones 2 skylights and windows must be fitted with spray proof covers which shall be permanently attached if the lowest part of the openings falls within the safety distance prescribed for the coamings of uncovered holds (para. 3-4.3.11). In this case, the height (h) of the superstructures in which the openings are provided is limited to the lowest point of these openings.

3-4.3.11 For vessels of type A and type B, the safety distance as defined in paragraph 3-4.1.1 must not be less than 600 mm zone 2.

For vessels of type C, as well as other vessels navigating with open holds, this distance shall be increased to 400 mm in zone 2. However, this increase applies only to the coamings of open holds.

3-4.3.12 The covers of Kingston valves and ice boxes must be waterproof.

3-4.3.13 The scuppers and freeing ports in bulwarks shall be of sufficient size to drain the decks of shipped water.

3-4.4 Special requirements for freeboard in zone 3.

3-4.4.1 For vessels of types A and B the safety distance must not be less than 300 mm.

3-4.4.2 For vessels of the type C the safety distance must not be less than 500 mm.

3-4.4.3 The basic freeboard of vessels with a continuous deck without superstructures and sheer shall be 150 mm.

3-4.4.4 The Administration may authorize a correction for the freeboard for vessels with superstructures and sheer providing that such correction is calculated in conformity with the rules of the Administration or of a recognized Classification Society.

In view of the reduction referred to above the minimum freeboard shall not be less than 0 mm.

CHAPTER 4

STABILITY AND SUBDIVISION

4-1 STABILITY

4-1.1 General requirements

4-1.1.1 A vessel shall be designed and constructed to provide sufficient intact stability for all anticipated service conditions.

4-1.1.2 A sufficient margin of stability shall be allowed for every stage of the voyage, taking into account any increase in weight such as might result from the absorption of water by the cargo or from icing, if the vessel is to operate under conditions where increases of this kind may occur.

4-1.1.3 The Administration may exempt a vessel from all stability checks provided that basic stability data are available for a sister vessel and it is shown to the Administration's satisfaction that all the stability information for that vessel can be validly used.

4-1.1.4 The Administration may consider the stability of the vessel as sufficient, if a stability information has been approved by a recognized Classification Society.

4-1.2 Special requirements for vessels navigating in zone 1

4-1.2.1 Proof of sufficient stability shall be provided by calculation. In cases where the Administration does not apply requirements of its own, a vessel may be considered as having sufficient stability when it satisfies the criteria given in the appendix to this chapter. Every vessel referred to in paragraph 4-1.2.3 shall, on completion, undergo an inclining test in the presence of an expert of the Administration to determine the displacement of the light vessel and the coordinates of its centre of gravity.

4-1.2.2 In the calculations mentioned in paragraph 4-1.2.1, the adverse effects which the carriage of certain bulk cargoes may have on stability shall be taken into account.

4-1.2.3 All new vessels and all vessels which have undergone conversions that may affect their stability shall be furnished with approved information on their stability.

4-1.2.4 In the case of certain cargo vessels known to be stable, the stability information may be based on calculations only, and an inclining test may be dispensed with.

4-1.2.5 The stability information referred to in paragraph 4-1.2.3 shall comprise:

The stability characteristics for typical loading conditions;

Information in the form of tables or diagrams which will enable the boatmaster to assess the stability of his vessel and verify whether it is sufficient in other loading conditions.

4-1.3 Special requirements for vessels navigating in zones 2 and 3

4-1.3.1 Vessels shall have sufficient stability. In cases where the Administration does not apply stricter requirements of its own, a vessel may be considered as having sufficient stability when it satisfies the criteria given in the appendix to this chapter.

4-2 SUBDIVISION

4-2.1 Watertight bulkheads

4-2.1.1 Watertight bulkheads carried up to the uppermost continuous deck shall be fitted in the places mentioned below.

4-2.1.2 A collision bulkhead shall be fitted at an appropriate distance from the forward perpendicular. If the vessel has a long forecastle, the Administration may require the collision bulkhead to be carried up to the forecastle deck.

4-2.1.3 In vessels navigating in zones 2 and 3 the collision bulkhead shall be between $0,04 L$ and $0,04 L + 2$ m. In vessels navigating in zone 1, the collision bulkhead shall be between $0,04 L$ and $0,08 L$ aft of the forward perpendicular, where L is the length defined in paragraph 3-4.1.1.

4-2.1.4 In vessels more than 25 m long, a bulkhead shall be fitted in the after part of the vessel at an appropriate distance from the after perpendicular having regard to the configuration of the vessel's after extremity.

4-2.1.5 The accommodation, engine rooms and boilers, and the working spaces forming part of these, shall be separated from the holds by watertight transverse bulkheads that extend up to the deck.

4-2.1.6 The Administration may require watertight bulkheads other than those mentioned above in regard to the vessel's design.

4-2.1.7 The Administration may permit derogations from these provisions, provided that equal safety is assured.

4-2.1.8 The bulkheads, the doors and closures in the bulkheads and the methods used for testing them shall comply with the requirements of the Administration or of a recognized Classification Society.

4-2.2 Openings in watertight bulkheads

4-2.2.1 General requirements applicable to all zones

4-2.2.1.1 No door or manhole shall be permitted in the collision bulkhead.

4-2.2.1.2 The number and dimensions of the openings in other watertight bulkheads shall be reduced to the minimum compatible with the design and operation of the vessel; satisfactory devices

shall be provided for the watertight closing of these openings, with indicators showing whether the devices are open or closed. It shall be possible to open and close doors on the spot from either side of the bulkhead.

4-2.2.1.3 Where shafts, pipes, scuppers, electric cables, etc., are carried through watertight subdivisions, arrangements shall be made to avoid impairing the watertight integrity of the bulkheads or decks.

4-2.2.1.4 In the collision bulkhead, no valves or cocks shall be fitted which open directly into the compartments lying abaft that bulkhead.

Such devices shall be avoided so far as possible in the other watertight bulkheads; if, however, such devices are fitted, they shall at all times be capable of being opened and closed from an accessible point situated above the uppermost continuous deck. Indicators shall be fitted to show whether the devices are open or closed.

4-2.2.1.5 If the drainage pipes of the forepeak tank pass through the collision bulkhead, each pipe shall be fitted with a valve which is controlled from a point situated above the freeboard deck and which is fitted to the collision bulkhead inside the forepeak.

4-2.2.2 Special requirements for vessels navigating in zone 1

4-2.2.2.1 Doors in watertight bulkheads shall be provided with a system for watertight closing, workable from either side of the bulkhead in proximity to the door and from a point above the maximum draught level. Each door shall be fitted with indicators which show, at all operating stations, whether it is open or closed.

In the accommodation and working spaces, however, and in the tweendeck immediately below the freeboard deck, remote control shall not be required. The doors shall be capable of being opened or closed on the spot from either side of the bulkhead. Hinged doors may be allowed.

Appendix

Criteria for checking the stability of vessels

1 General principles and definitions

1.1 The stability criteria do not take into account any shifting of cargo.

1.2 A vessel shall be deemed sufficiently stable if, for the loading conditions considered in 1.7, it satisfies:

1.2.1 The requirement that the initial metacentric height, corrected for the free-surface effects of liquid cargo, should have a positive value;

1.2.2 Weather criteria, as determined in accordance with the requirements of section 2 below;

1.2.3 The requirements for stability, as determined in accordance with the requirements of section 3 below with respect to the type and purpose of the vessel.

1.3 The values for the moments of the external forces exerted on the vessel shall be taken as constant for the whole range of inclination of the vessel.

1.4 The definitions used in this appendix, apart from those laid down in other paragraphs of these Recommendations are as follows:

1.4.1 Liquid cargo: all liquids carried on the vessel, including: cargo, stores, ballast, etc.;

1.4.2 Stores: cargo consumed in the operation of the vessel (fuel, lubricating oil, fresh water, provisions, etc.);

1.4.3 Empty vessel: a vessel that is fully prepared and equipped with machinery and systems, but with no cargo, passengers, liquid ballast or stores;

1.4.4 Vessel carrying fixed containers: vessels all of whose containers are fixed and having the equipment necessary to secure containers to the satisfaction of the Administration;

1.4.5 Critical angle φ_{f1} : angle of heel at which water begins to fill the vessel through unsecured openings, but not exceeding the angle at which the edge of the freeboard deck is submerged, or at which the middle of the bilge leaves the water;

1.4.6 Capsizing angle φ_c : angle of heel at which the vessel begins to capsize under the effect of the heeling moment.

1.4.7 Permissible angle φ_{perm} : angle of heel which should not be exceeded and which should be prescribed by the competent authority for the type of vessel under consideration. In general it corresponds to the critical angle φ_{f1} as defined in 1.4.5, but should not be greater than the capsizing angle as defined in 1.4.6.

1.5 The permissible heeling moment for all required loading conditions shall be determined by means of a static or a dynamic stability curve in accordance with the values of permissible angle of heel given for the various stability criteria in sections 2 and 3 below.

For vertical-sided vessels, the maximum permissible heeling moments may be determined without constructing a curve, on the basis of the following formulae:

1.5.1 For the dynamic effect of the external forces:

$$M_{perm} = 0.0856 \cdot \Delta \cdot \overline{GM}' \cdot q_{perm} \quad (kNm)$$

1.5.2 For the static effect of the external forces

$$M_{perm} = 0.1712 \cdot \Delta \cdot \overline{GM}'.$$

where:

- ? = displacement of the vessel for the given loading condition; in tonnes;
- \overline{GM}' = initial metacentric height corrected for the free-surface effects of liquid cargo, in metres;
- M_{perm} = permissible heeling moment;
- q_{perm} = permissible angle of heel, in degrees.

1.6 The free-surface effects of liquid cargo shall be taken into account in the calculation of stability.

For liquid cargo in tanks where the quantity of liquid changes during the operation of the vessel, the calculation shall be made with the tanks filled to 50% of their capacity.

A tank filled with liquid cargo to more than 95% of its capacity shall be deemed completely full.

In calculating the stability of a vessel, the liquid cargo residues commonly found up to a depth of 5 cm in evacuated tanks shall not be taken into account.

If the vessel is intended for the transport of various types of liquid cargo, the calculation shall assume the most unfavourable loading condition.

1.7 The stability of vessels, according to their type or purpose, should be checked for the most unfavourable loading conditions, at least in the cases shown in the following table:

Type of vessel	Loading conditions
Passenger vessels	(i) With no passengers or cargo, 10% stores (ii) With 100% passengers and baggage, 10% stores, 100% cargo (iii) With 100% passengers and baggage, 100% stores, 100% cargo
All other vessels	(i) With 10% stores, with no cargo (ii) With 100% stores and 100% cargo

If the vessel carries solid ballast, its mass shall be included as part of the light weight.

For all loading conditions, the inclusion of liquid ballast as part of the load should be agreed with the Administration.

2 Weather criteria

2.1 The vessel shall satisfy the weather criterion if, under the most unfavourable loading condition, the permissible moment produced by dynamic inclinations of the vessel is equal to or greater than the heeling moment resulting from the dynamic pressure of the wind, i.e. if the following condition is met:

$$M_{perm} \geq M_{wst}$$

where:

M_{perm} = permissible moment produced by the dynamic inclinations of the vessel corresponding to the critical angle or to the capsizing angle, if the latter is smaller;

M_{wd} = heeling moment resulting from the dynamic pressure of wind, as in 2.3.

2.2 Certain types or individual vessels need not be checked for stability with respect to the weather criterion if the competent authorities are satisfied beyond doubt that the stability requirements are met by the said vessels in any case.

$$M_{wd} = 0.001 \cdot P_{wd} \cdot A_w \cdot z \text{ (kNm)}$$

2.3 The heeling moment resulting from the dynamic pressure of the wind shall be taken as:

where:

P_{wd} = specific wind pressure, whose value shall be taken from the following table for the navigation zone of the vessel and for the lever arm;

Specific wind pressure P_{wd} (Pa):

z (m) Navigation zone	1	2	3	4	5	6
2	232	279	318	345	369	388
3	178	217	247	269	286	302

A_w = effective lateral area (m²) - see below;

Z = level arm of free-floating vessel = distance between the centre of gravity of the lateral area and the plane of the load waterline considered, when the vessel is upright in calm water (m).

The effective lateral area should include all above-water projected surfaces (hull, superstructure, deck machinery, deck cargo, and other elements of the above-water part of the vessel) at the centre of the vessel when it is upright. The projected areas of structures of round section located separately on the deck should be assumed to have an effective coefficient of flow of 0.6.

The lateral area of lattice-type structures above the waterline shall be calculated on the basis of the areas bounded by these structures multiplied by the coefficients of fullness taken from the following table:

Type of lattice structure	Coefficient of fullness
Life rails	
without guard mesh	0.2
with guard mesh	0.6
Other lattice structures	0.3 – 0.5

3 Stability requirements for different types of ships

3.1 Passenger vessels

3.1.1 The stability of passenger vessels should satisfy the following requirements:

3.1.1.1 The angle of heel under the most unfavourable distribution of passengers in terms of width and height should not exceed an angle at which 75% of the freeboard or of the distance between the waterline and unsecured openings, whichever is less, is submerged, and that angle should not exceed 10°;

3.1.1.2 The angle of heel should not exceed the critical angle; furthermore that angle should not exceed 12° under:

the combined effect of the heeling moments resulting from the most unfavourable crowding of passengers on one side M_{pass} and from the effect of the centrifugal force exerted by turning M_{cf} ;

the combined effect of the heeling moments resulting from the most unfavourable crowding of passengers on one side M_{pass} and from the static effect of wind M_{wst} .

3.1.2 The stability of passenger vessels should be checked against the supplementary requirements for the loading conditions shown in the table at paragraph 1.7 and for the loading condition which corresponds to the most dangerous number of passengers with baggage and 10% of stores.

3.1.3 The heeling moment of the vessel resulting from the static effect of wind shall be determined by the formula:

$$M_{wst} = 0.001 \cdot P_{wst} \cdot A_w \cdot \left(z + \frac{d}{2}\right) \text{ (kNm)}$$

or, alternatively

$$M_{wst} = 0.1 \cdot A_w \cdot \left(z + \frac{d}{2}\right) \text{ (kNm)}$$

where:

P_{wst} = specific pressure exerted by the static effect of wind, amounting to 50% of the pressure value shown in the first table at paragraph 2.3 (Pa);

A, z = as in paragraph 2.3.

3.1.4 The heeling moment resulting from the effect of the centrifugal force exerted by turning the vessel M_{cf} shall be determined by the formula:

$$M_{cf} = \frac{c \cdot \Delta \cdot v^2 \cdot \left(z_g - \frac{d}{2}\right)}{L} \text{ (kNm)}$$

or alternatively,

$$M_{cf} = \frac{5 \cdot \Delta \cdot \left(z_g - \frac{d}{2}\right)}{L} \text{ (kNm)}$$

where:

c = a coefficient which shall be determined in manoeuvrability trials and which shall not be less than 0.2;

v = speed of the vessel at full power in calm water (m/s);

z_g = height of the vessel's centre of gravity above the base line (m);

L = maximum length of the hull, measured at maximum draught (m).

3.1.5 The heeling moment of the vessel resulting from the crowding of passengers on one side M_{pass} should be determined having regard to the following conditions:

3.1.5.1 The distribution of passengers should correspond to the most dangerous crowding possible under normal operating conditions, taking into account decks accessible to passengers. In the case of vessels with more than one deck in use for passengers, the most unfavourable distribution of these passengers over the various decks shall be assumed;

3.1.5.2 The number of passengers shall be calculated at the rate of at least four persons per square metre of free deck area;

3.1.5.3 The width of seating space per person shall be taken to be 45 cm;

3.1.5.4 The mass per passenger shall be taken to be 75 kg;

3.1.5.5 The centre of gravity of standing passengers shall be taken to be 1.0 m above the deck level, and that of sitting passengers 0.3 m above the seat.

3.2 Cargo vessels

3.2.1 The stability of cargo vessels carrying deck cargo or cargo in holds, where the centre of gravity of the lateral area of the vessel and cargo is more than 2 m above the load waterline considered, should satisfy the supplementary requirement laid down in 3.2.2.

3.2.2 The heeling moment of a vessel resulting from the static effect of wind M_{wst} should not exceed the maximum permissible moment produced by the static inclinations of the vessel M_{perm} , i.e., the following condition should be met:

$$M_{perm} \geq M_{wst}$$

where:

M_{perm} = maximum permissible moment produced by the static inclinations of the vessel = moment corresponding to an angle of heel representing 80% of the critical angle;

M_{wst} = as in 3.1.3.

3.2.3 All vessels for which the ratio of the total power of the main machinery N_e to the maximum permissible displacement Δ is $N_e/\Delta > 0.75$ kW/t shall be checked with respect to the turning criterion as in 3.1.4. Their angle of heel should not in this case exceed 80% of the critical angle.

3.3 Tugs

3.3.1 Tug vessels shall have sufficient stability if the maximum permissible moment of the vessel M_{perm} (see 2.1) is greater than or equal to the sum of the heeling moments resulting from the dynamic effect of wind M_{wd} (see 2.3) and the dynamic effect of the lateral component of the bollard pull force M_t (see 3.3.2), i.e., if the following condition is met:

$$M_{perm} \geq M_{wst} + M_t$$

3.3.2 The heeling moment resulting from the dynamic pressure of the lateral component of the bollard pull force shall be determined by the formula:

$$M_t = 1.1 \cdot T \cdot (z_t - d)$$

where:

z_t = height of the point of application of the bollard pull force above the base line (m);

T = maximum bollard pull force measured on checking at moorings (kN).

In cases where T is not known, the following values shall be assumed for calculation purposes:

For $\Delta \leq 30$ t:

T = 0.13 N_e - for tugs without propeller nozzles;

T = 0.20 N_e - for tugs with propeller nozzles;

for $\Delta \geq 30$ t:

T = 0.16 N_e - for tugs without propeller nozzles;

T = 0.20 N_e - for tugs with propeller nozzles:

where N_e = the total power of the main machinery (kW).

3.3.3 In addition to the conditions laid down in 3.3.1, the stability of each tug should satisfy the following supplementary requirement:

The angle of heel resulting from the combined effect of the heeling moments produced by the dynamic pressure of wind M_{wd} and the effect of the centrifugal force on turning M_{cf} (see 3.1.4) should not exceed the critical angle and should in no case exceed 15°.

3.4 Vessels carrying containers

The following two methods of calculation of stability of vessels carrying containers shall be considered as equally acceptable.

Method A

3.4.1 In the case of the vessels carrying non-fixed containers any calculation method used to determine the vessel's stability shall conform to the following requirements:

3.4.1.1 The metacentric height \overline{MG} shall not be less than 1.00 m;

3.4.1.2 Under the combined action of the centrifugal force produced by the turning of the vessel, the thrust of the wind and the flooded free surfaces, the heel shall not be more than 5° and the deck side shall not be submerged;

3.4.1.3 The heeling arm resulting from the centrifugal force due to the turning of the vessel shall be determined by the following formula:

$$h_{cf} = C_{cf} \cdot \frac{v^2}{L_F} \cdot \left(z_g - \frac{d'}{2} \right) \quad (m)$$

where,

- C_{cf} = parameter: ($C_{cf} = 0.04$) (s^2/m),
 v = maximum speed of vessel in relation to the water (m/s),
 z_g = height of centre of gravity of loaded vessel above the baseline (m),
 d' = average draught of loaded vessel (m),
 L_F = length of the hull, measured at maximum draught (m).

3.4.1.4 The heeling arm resulting from the thrust of the wind shall be determined according to the following formula:

$$h_w = C_w \cdot \frac{A_w}{\Delta} \cdot \left(z + \frac{d'}{2} \right) \quad (m)$$

where,

- C_w = parameter: ($C_w = 0.025$) [t/m^2],
 A_w = lateral surface above the water when vessel is loaded (m^2),
 Δ = displacement of loaded vessel (t),
 z = height of centre of gravity of lateral surface A above the water in relation to the water-line (m),
 d' = average draught of loaded vessel (m).

3.4.1.5 The heeling arm resulting from the free surfaces exposed to rainwater and residual water inside the hold or double bottom shall be determined according to the following formula:

$$h_{fs} = \frac{C_{fs}}{\Delta} \cdot \sum (b \cdot l \cdot (b - 0.55\sqrt{b})) \quad (m)$$

where,

- C_{fs} = parameter: ($C_{fs} = 0.015$) [t/m^2],
 b = breadth of hold or section of hold concerned (m)^{1/}
 l = length of hold or section of hold concerned (m)^{1/}
 Δ = displacement of loaded vessel (t).

^{1/} Sections of hold of free surfaces open to water result from separation by watertight lengthwise or transverse partitions, forming separate sections.

3.4.1.6 For each load, half the fuel and freshwater supply must be taken into account.

3.4.2 The stability of a vessel loaded with non-fixed containers shall be considered adequate when the actual z_g is not more than the z_g max produced by the formula. The z_g max must be calculated for various displacements covering the whole range of possible draughts.

$$3.4.2.1 \quad z_{g \max} = \frac{\overline{KM} + \frac{B_F}{2F} \cdot (C'_{cf} \cdot \frac{d_a}{2} - h_w - h_{fs})}{\frac{B_f}{2F} \cdot C'_{cf} + 1} \quad (m)$$

For $\frac{B_F}{2F}$, no value below 11.5 shall be used ($11.5 = 1/\tan 5^\circ$).

$$3.4.2.2 \quad z_{g \max} = \overline{KM} - 1.00 \quad (m)$$

The smaller value for $z_{g \max}$ produced by 3.4.2.1 or 3.4.2.2 shall apply,

where,

$z_{g \max}$ = maximum permissible height of the centre of gravity of the loaded vessel above the baseline (m),

\overline{KM} = metacentric height above the baseline (m) according to the approximation formula in 3.4.3,

F = actual freeboard at 2 L (m),

C'_{cf} = parameter for centrifugal force produced by turning,

$$C'_{cf} = \frac{(0.7 \cdot v)^2}{9.81 \cdot 1.25 \cdot L_F} = 0.04 \cdot \frac{v^2}{L_F} \quad [-]$$

v = maximum speed of vessel in relation to the water (m/s),

d_a = average draught (m),

h_w = heeling arm produced by lateral wind thrust (see 3.4.3.4) (m),

h_{fs} = sum of heeling arms produced by flooded free surfaces (see 3.4.3.5) (m),

B_F = breadth of the hull, measured from the outside of the side plating at the maximum draught line.

3.4.3 Approximation formula for \overline{KM}

Where there is no curve plan available, the value of \overline{KM} for the calculation, according to 3.4.4, can be determined, for example, by the following approximation formulae:

3.4.3.1 Pontoon vessels

$$\overline{KM} = \frac{B_F^2}{(12.5 - \frac{d_a}{H}) \cdot d_a} + \frac{d_a}{2} [m]$$

where,

H = side height of the hull which is the shortest vertical distance between the top of the keel and the lowest point of the deck at shipside.

3.4.3.2 Other vessels

$$\overline{KM} = \frac{B_F^2}{(12.7 - 1.2 \cdot \frac{d_a}{H}) \cdot d_a} + \frac{d_a}{2} (m)$$

3.4.4 In the case of vessels carrying fixed containers, any calculation method used to determine the stability of the vessel shall conform to the following requirements:

3.4.4.1 The metacentric height \overline{MG} shall not be less than 0.50 m;

3.4.4.2 Under the combined action of the centrifugal force produced by the turning of the vessel, the thrust of the wind and the flooded free surfaces, no hull opening shall be submerged;

3.4.4.3 The heeling arm resulting from the centrifugal force produced by the turning of the vessel, the thrust of the wind and the flooded free surfaces shall be determined by the formulae referred to under paragraphs 3.4.1.3-3.4.1.5;

3.4.4.4 For each load, half the fuel and fresh water supply must be taken into account.

3.4.5 The stability of a vessel loaded with fixed containers shall be considered adequate when actual z_g is less than or equal to the $z_{g \max}$ calculated for the various displacements resulting from the possible variation in height.

Method B

3.4.6 A cargo of containers is considered to be fixed when each individual container is firmly secured to the vessel hull by guides or tensioners and when its position cannot be altered during navigation.

3.4.7 The container cargo of vessels navigating in zone 1 must be fixed.

3.4.8 The equipment used to secure containers must satisfy the requirements laid down by the Administration.

3.4.9 The requirement regarding the stability of vessels carrying fixed containers is considered to be met if the criteria for the stability of cargo vessels set out in para. 3.2 have been satisfied.

3.4.10 The stability of vessels carrying non-fixed containers must satisfy the following additional requirements:

3.4.10.1 The metacentric height \overline{GM} shall not be less than 1.00 m.

3.4.10.2 The permissible angle of heel θ_{perm} is compared with the angle of heel $\theta_{wst/cf}$ resulting from the combined effect of the heeling moments produced by the static pressure of wind M_{wst} (see para. 3.1.3 above) and the effect of the centrifugal force on turning M_{cf} (see para. 3.1.4 above)^{2/}. This angle must not be greater than 5° or the critical angle θ_n at which the upper edge of the freeboard deck is submerged, with a view to determining which of these angles is the smaller; in other words one of the following requirements must be satisfied:

$$q_{wst/cf} \leq q_{perm} = 5^\circ$$

or

$$q_{wst/cf} \leq q_{perm} = q_n, \text{ if}$$

$$q_n < 5^\circ$$

3.4.10.3 The angle of heel $\theta_{wst/cf}$ should be determined from the static stability diagram in relation to the value of M_{wst} and M_{cf} as a result of constructions given in figure 3.4.10.3 where the origin of the coordinates is transposed to point O' on curve M, corresponding to the static angle of heel θ_{wst} , arising as a result of the application of the static moment M_{wst} , determined in accordance with 3.1.3.

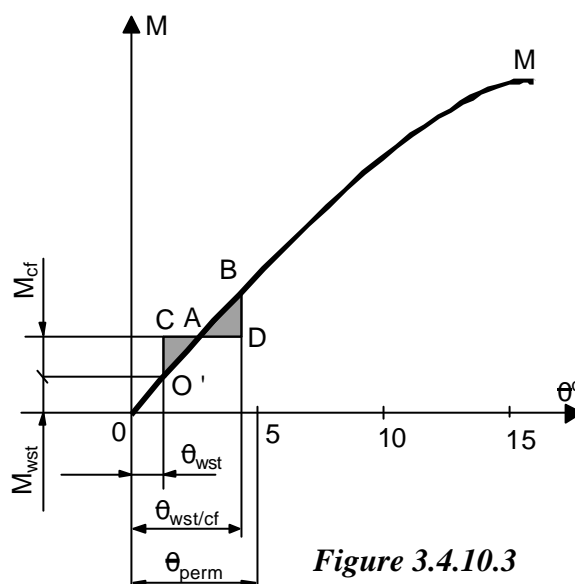

Figure 3.4.10.3

The angle of heel $\theta_{wst/cf}$ is determined by selecting a straight line BD parallel to the ordinates axis, assuming that the hatched areas O'CA above the curve up to the moment M_{cf} and ABD below the curve are equal.

3.4.10.4 In determining the permissible moment produced by the dynamic inclinations M_{perm} , the permissible angle of heel θ_{perm} must be no greater than that given in para. 3.4.10.2.

3.4.10.5 If the requirements laid down in paras. 3.4.10.2 and 3.4.10.4 are not satisfied containers must be secured.

^{2/} In calculating M_{cf} in accordance with paragraph 3.1.4 the speed of the vessel before it begins its turn is taken as 0.8 of the full speed.

4 Supplementary requirements for vessels in navigation zone 1

4.1 General provisions

4.1.1 The stability of vessels intended for navigation in zone 1 should satisfy the requirements of sections 1, 2 and 3 for vessels of zone 2, and also the supplementary requirements of this section. Furthermore the conditions for satisfactory stability laid down in paragraphs 1.2.1 and 1.2.2 should also be met for the simultaneous rolling of the vessel.

4.1.2 Compliance with the applicable requirements of the IMO Recommendations for sea-going vessels may be considered as equivalent to compliance with these Recommendations.

4.1.3 When checking stability with respect to the weather criterion, the heeling moment resulting from the dynamic pressure of wind M_{wd} shall be calculated taking the specific wind pressure P_{wd} for navigation zone 2, as in the table at paragraph 2.3.

4.1.4 The permissible heeling moment M_{perm} shall be determined by means of the stability curve, taking into account the value for the amplitude of roll calculated as in 4.2.

4.1.5 The critical angle shall be taken to be the angle of heel at which water begins to fill the vessel through unsecured openings in the side plating or on the deck. The maximum angle may not extend further than the upper edge of the side coaming of the cargo hatch or the upper edge of the expansion trunks of tankers.

4.2 Calculation of the value for the amplitude of roll of a vessel

4.2.1 The value for the amplitude of roll η_m of a flat-bottomed vessel with a bilge radius of 0.05 B or more not fitted with bilge keels shall be determined from the following table in terms of a value m calculated by the formula:

$$m = 0.66 \cdot m_1 \cdot m_2 \text{ (s}^{-1}\text{)}$$

where m_1 and m_2 = factors determined in accordance with paragraphs 4.2.2 and 4.2.3.

$m \text{ (s}^{-1}\text{)}$	0.40	0.60	0.80	1.00	1.20	1.40	1.60 or more
$\eta_m^{(o)}$	9	10	13	17	20	23	24

4.2.2 The factor m_1 shall be calculated by the formula:

$$m_1 = \frac{m_o}{\sqrt{GM}} \text{ (s}^{-1}\text{)}$$

where:

\overline{GM} = initial metacentric height for the loading condition considered, without correction for the free-surface effects of liquid cargo;

m_o = a value from the following table in relation to the parameter η determined by the formula:

$$n_1 = \frac{B \cdot \overline{GM}}{z_g \cdot \sqrt[3]{\Delta}}$$

where:

? = see paragraph 1.5;

z_g = see paragraph 3.1.4.

n_1	0.1 or less	0.15	0.25	0.50	0.75	1.00	1.50	2.00	2.50	3.0 or more
m_b	0.42	0.52	0.78	1.38	1.94	2.40	3.00	3.00	3.50	3.60

4.2.3 The non-dimensional factor m_2 shall be taken from the following table as a function of the ratio B/d.

B/d	2.5 or less	3.0	3.5	4.0	5.0	6.0	7.0	8.0	9.0	10 or more
m_2	1.0	0.9	0.81	0.78	0.81	0.87	0.92	0.96	0.99	1.0

4.2.4 In cases where the bilge radius is less than 0.05 B, the value for the amplitude of roll determined in accordance with paragraph 4.2.1 may be reduced to a value of ? determined by the formula:

$$q = q_m \cdot \left(0.75 + \frac{5r}{B}\right) \text{ (degrees)}$$

where:

r = bilge radius (m).

4.2.5 The amplitude of roll q_m determined in accordance with paragraph 4.2.1 shall be taken into account in the stability curve (see sketches 4.2.5-1 (a) and (b) and 4.2.5-2 (a) and (b)).

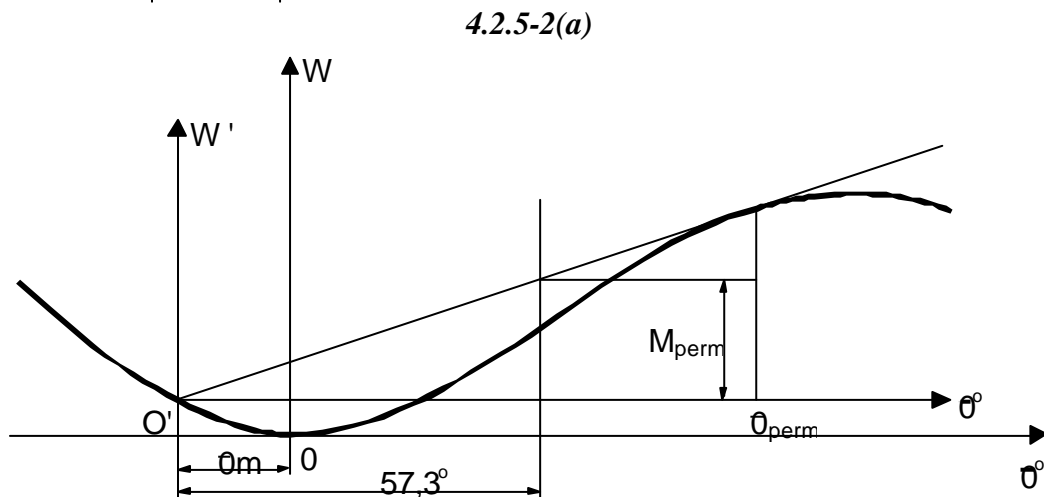
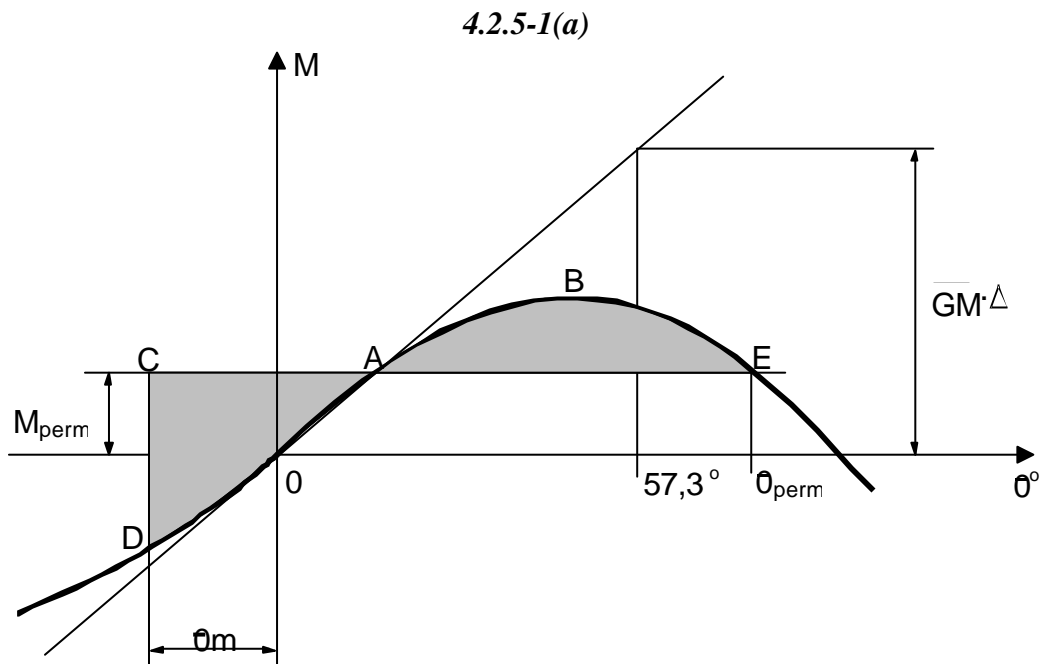

Explanation of sketches 4.2.5-1 (a) and (b) and 4.2.5-2 (a) and (b)

Sketches 4.2.5-1 (a) and 4.2.5-1 (b) show static stability curves constructed taking into account the amplitude of roll θ_m in the following manner:

The curves are amplified by a static stability curve in the area of negative angles of heel to the abscissa θ_m (segment O-D);

In order to determine the maximum heeling moment, the area on the static stability diagram below the curve up to angle θ_{perm} (ABE) should be equal to the area above the curve (ACD);

The diagram in sketch 4.2.5-1 (a) shows a case in which the angle θ_{perm} equals the capsizing angle, and the diagram in sketch 4.2.5-1 (b) a case in which the angle θ_{perm} equals the angle of maximum heel which is permissible on other grounds.

4.2.5-1(b)

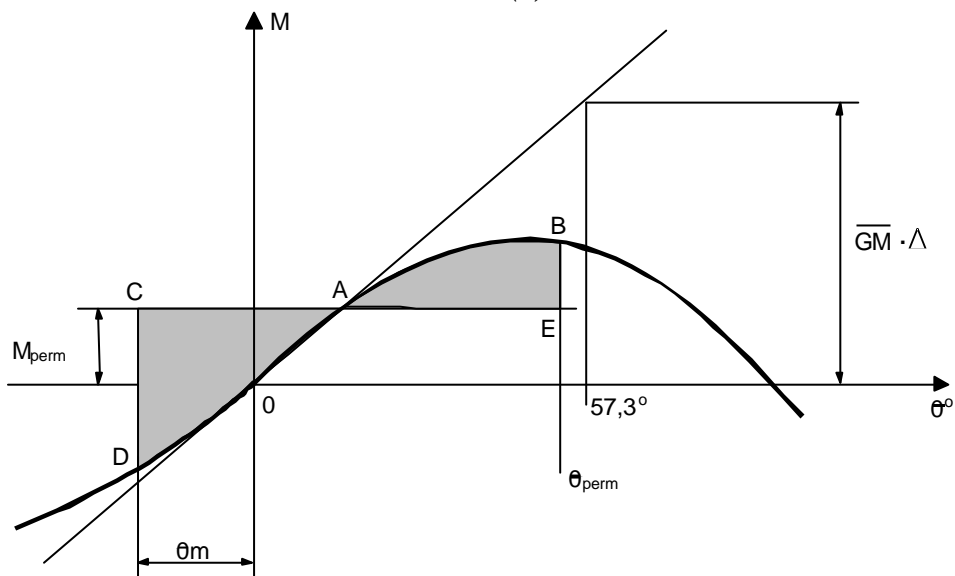

4.2.5-2(b)

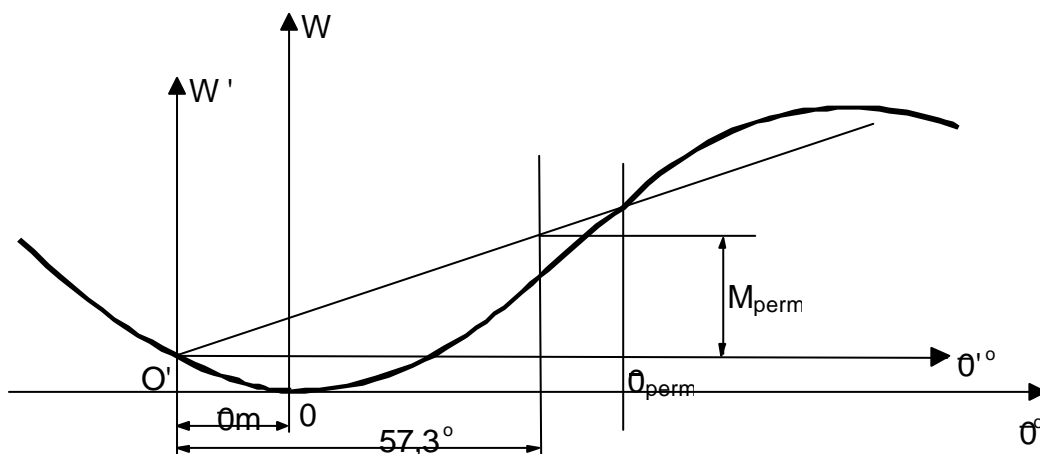

Sketches 4.2.5-2 (a) and 4.2.5-2 (b) show static stability curves constructed taking into account the amplitude of roll θ_m in the following manner:

The curves are amplified by a dynamic stability curve in the area of negative angles of heel to the abscissa θ_m ;

A tangent to the dynamic stability curve is produced through new origin O' in order to determine the maximum capsizing moment M_{perm} (cf. sketch 4.2.5-2 (a)), or a straight line is produced through the point of intersection of the dynamic stability curve with a vertical straight line drawn from the point of the angle of heel θ_{perm} which is permissible on other grounds;

The segment at an angle of 1 radian gives the value of the maximum permissible heeling moment.

CHAPTER 5

MACHINERY

5-1 GENERAL

5-1.1 The machinery space is the part of the vessel housing the main and auxiliary machinery. The machinery space is divided up as follows:

- (a) The main engine room - the space where the main machinery is installed;
- (b) The engine room - the space where only auxiliary machinery, namely internal combustion engines, is installed;
- (c) The boiler room - the space housing a fuel-operated installation designed to produce steam or to heat a thermal fluid.

5-1.2 The main machinery is that designed to drive the propelling mechanisms and/or serving the main purpose of the vessel.

5-1.3 The auxiliary machinery is that which contributes to the operation of the main machinery and that which supplies the vessel with all forms of power necessary for the operation of the vessel's various systems and installations.

5-1.4 Machinery and their attachments shall be designed built and installed in accordance with the state of the art, the rules of the Administration and/or of a recognized Classification Society. It shall be possible to start and stop the machinery, and if necessary to reverse the main machinery, reliably, quickly and safely.

The main machinery and auxiliary machinery, boilers and pressure vessels, together with their accessories shall be fitted with safety devices.

5-1.5 The liquid fuel for the main or auxiliary machinery shall have a flashpoint above 55°C. In certain cases, such as for lifeboat engines, the Administration may allow a fuel with a flashpoint below 55°C.

5-1.6 Installations requiring special inspections, such as boilers and pressure vessels, shall comply with the rules of the Administration or with the rules of a recognized Classification Society.

5-1.7 The fuel system, the lubricating and cooling-water systems and the starting devices shall conform to the requirements of the Administration or to the rules of a recognized Classification Society.

5-1.8 The following parameters of the main machinery shall be monitored by means of suitable devices which trigger an alarm once a critical level has been reached:

- (a) The temperature of the cooling water;
- (b) The lubricating oil pressure for the engines and transmissions;
- (c) The oil and air pressure of the reversing units, reversible transmissions or propellers.

5.1.9 Where vessels have only one main propulsion engine that engine shall not be shut down automatically except in order to protect against over-speed of the engine.

5-2 MAIN MACHINERY/SHAFTING

5-2.1 The main machinery power shall make the vessel sufficiently manoeuvrable under normal operating conditions.

5-2.2 The control devices shall be so constructed that they cannot be accidentally moved from their appointed position.

5-2.3 A system of two-way communication shall be provided between the main machinery space and the wheelhouse.

5-2.4 Where the main machinery is remote-controlled, a local control station shall be provided.

5-2.5 It shall be possible to turn the main machinery over in complete safety.

5-2.6 If the propeller shafts cannot be disconnected, they shall be equipped with suitable blocking devices.

5-2.7 Shafting shall be designed in such a way as to prevent the spread of water-polluting lubricants.

5-3 MACHINERY SPACE

5-3.1 In the machinery space the machinery, accessories and equipment shall be so placed as to be readily accessible and safe for operation, dismantling and maintenance.

5-3.2 All moving parts of the machinery and transmissions dangerous to members of the crew shall be fitted with appropriate protective devices.

5-3.3 The machinery and equipment shall be installed on sturdy and rigid seatings firmly fixed to the vessel's hull.

5-3.4 The machinery space shall be provided with efficient ventilation

5-3.5 The floor plates of the machinery space shall be fixed and made of sufficiently firm non-slip sheet metal. They have to be removable.

5-3.6 All doors and hatch covers usable as exits from the machinery space shall open and close from both inside and outside. The covers of skylights not intended for use as exits shall be closable from outside.

5-4 GAS EXHAUST SYSTEM

5-4.1 All exhaust gases shall be evacuated outside the vessel. All necessary steps shall be taken to prevent dangerous gases from penetrating the various compartments.

5-4.2 Exhaust pipes shall be suitably shielded, insulated or cooled. Protection against physical contact may suffice outside the engine rooms.

5-4.3 Gas exhaust pipes which pass through accommodation or the wheelhouse shall, in those compartments, be enclosed within a gastight protective sleeve. The space between the exhaust pipe and the sleeve shall communicate with the open air.

5-4.4 The exhaust pipes shall be arranged and protected in such a way that they cannot cause a fire. If the exhaust pipes run alongside or pass through inflammable materials, those materials shall be effectively protected.

5-5 FUEL SYSTEM

5-5.1 Liquid fuels shall be stored in steel tanks or, if so required by the design of the vessel, in an equivalent material in terms of fireproofing, this forming part of the hull or being firmly attached to this. That requirement shall not apply to tanks having a capacity of no more than 12 litres that have been incorporated in ancillaries at the factory. No tank for any liquid fuel shall be installed forward of the collision bulkhead.

5-5.2 Fuel tanks shall not be situated near sources of heat. Daily-service tanks, their fittings and connections shall not be located above engines or gas exhaust pipes. Drip-trays shall be placed under daily-service tanks in order to collect any leaking fuel.

5-5.3 Fuel transfer pumps, fuel separators and oil burners, shall be fitted not only with a local control device but also with a stopping device accessible at all times and situated outside the spaces where they are installed.

5-5.4 Fuel pipes shall be independent of other piping systems.

5-5.5 Fuel may be heated only by devices allowed by the Administration.

5-5.6 Fuel tanks, their piping and other accessories shall be so designed and installed that no fuel or gas can escape into the vessel. Tank valves intended for fuel sampling or water drainage

shall be of a self-closing type. Drip-trays to collect any leaking fuel or oil shall be placed under fittings and fuel and oil tank connections.^{3/}

5-5.7 Fuel shall be supplied by means of a leak-proof connection.

5-5.8 If machinery can run on either light or heavy fuel, measures shall be taken to avoid mixing different kinds of fuel by accident.

5-5.9 At tank outlets the pipeline for the distribution of liquid fuels shall be fitted with a shutoff device that can be operated from the deck. That requirement shall not apply to tanks mounted directly on the engine. Fuel pipes, their connections, seals and fittings shall be made of materials that are able to withstand the mechanical, chemical and thermal stresses to which they are likely to be subjected. The fuel pipes shall not be subjected to any damaging effects of heat and it must be possible to monitor them throughout their length.

5-5.10 Pipes for filling liquid-fuel tanks other than daily supply tanks shall have their opening above the deck and shall be fitted with a cap. Every such tank shall be fitted with a vent pipe leading to the open air above the deck and so placed that no water can enter it. Its cross-section shall be at least 1.25 times the cross section of the filler neck. The filler openings for fuel tanks shall be marked distinctly.

5-5.11 Fuel- and lubricating oil tanks shall be provided with a capacity-gauging device that is legible right up to the maximum filling level. External gauge columns shall be effectively protected against impacts, shall be fitted with self closing valves at their base and shall be attached at their upper part to the tanks above their maximum filling level. The material used for the gauge columns shall not deform under normal ambient temperatures.

5-5.12 Tanks which directly supply essential machinery shall be equipped with a device that gives a visual and acoustic signal in the wheelhouse when their degree of filling is no longer sufficient for reliable operation.

5-5.13 Tanks for liquid fuel or lubricating oil shall not have vertical common walls with accommodation spaces. Fuel tanks shall not have common surfaces with drinking water tanks.

5-5.14 Liquid fuel tanks shall be provided with openings having leak-proof closures that are intended to permit cleaning and inspection.

^{3/} Note by the secretariat: The Working Party SC.3/WP.3, at its nineteenth session, agreed to drop this additional third sentence if a similar provision would find its place in the text of the newly-elaborated chapter 18 of the annex to resolution No. 17, revised, "Prevention of water pollution" (TRANS/SC.3/WP.3/39, para. 9, chapter 5 (x)). The attention of the Working Party is drawn to paragraph 18-2.1 of the chapter 18 (document TRANS/SC.3/104/Add.5) reading: "All necessary steps should be taken to reduce the filtration of oil on board vessels. Drip-trays to collect any leaking fuel or oil shall be placed under fittings and fuel and oil tank connections. Drip-trays shall also be placed under daily-service tanks in order to collect any leaking fuel". The Working Party may wish to decide whether the third sentence of paragraph 5-5.6 (and possibly, 5-5.2) should be deleted and fully reproduced in paragraph 18-2.1 of the chapter 18.

5-5.15 Fire hazards which might result from the splashing of liquid fuel or other inflammable liquids on to hot surfaces shall sufficiently be prevented by:

- (i) Suitable construction, arrangement or shielding of the high pressure pipes carrying such liquids;
- (ii) Heat-resistant insulation of hot surfaces by oilproof or sheet-metal shielding.

5-6 BILGE PUMPING AND DRAINAGE SYSTEMS

5-6.1 It shall be possible to pump each watertight compartment dry separately. However, that requirement shall not apply to compartments that are normally sealed hermetically during operation.

5-6.2 Vessels requiring a crew shall be equipped with two separate bilge pumps which shall not be installed within the same space. At least one of these shall be motor driven. However, if the power units for such vessels develop less than 225 kW or weigh less than 350 t gross respectively, or where vessels not intended for the carriage of goods have a displacement of less than 250 m³, either a manually-operated or motor-driven pump will suffice. Each of the required pumps shall be capable of use on each sealed compartment.

5-6.3 The pumping capacity of the first bilge pump shall be calculated via the formula:

$$Q_1 = 0.1 \cdot d_1^2 \text{ [l/min]}$$

d_1 is calculated via the formula

$$d_2 = 1.5 \sqrt{L(B+H)} + 25 \text{ [mm]}$$

The pumping capacity of the second bilge pump shall be calculated, in l/min via the following formula:

$$Q_2 = 0.1 \cdot d_2^2 \text{ [l/min]}$$

d_2 is calculated by the formula :

$$d_2 = 2 \sqrt{l(B+H)} + 25 \text{ [mm]}.$$

However, the value d_2 may be taken not to exceed value d_1 . The length of the longest sealed compartment shall be taken to be l in order to determine Q_2 .

In these formulae:

- l = the length of the corresponding sealed compartment, in m;
- d_1 = the calculated internal diameter of the drainage pipe, in mm;
- d_2 = the calculated internal diameter of the drainage spur, in mm.

5-6.4 Where the drainage pumps are connected to a drainage system the drainage pipes shall have an internal diameter of at least d_1 , in mm, and the drainage spurs an internal diameter of at least d_2 , in mm. Where vessels are less than 25 m in length these values may be reduced to 35 mm.

5-6.5 Only self-priming drainage pumps are acceptable.

5-6.6 There must be at least one strainer on both the starboard and port sides of all flat-bottomed, drainable compartments that are wider than 5 m.

5-6.7 It may be possible to drain the rear beak via the main engine room by means of an easily accessible, automatically closable set of pipes.

5-6.8 The drainage spurs for the various compartments shall be linked to the main drain by means of a lockable non-return valve.

The compartments or other spaces fitted out for ballast may only be linked to the drainage system by means of a single closing device. That requirement shall not apply to holds fitted out for ballast. Such holds shall be filled with ballast water by means of ballast piping that is permanently installed and independent of the drainage pipes, or by means of spurs consisting of flexible pipes or intermediate pipes that can be connected to the main drain. Water intake valves located in the base of the hold shall not be permitted for this purpose.

5-6.9 The hold bottoms shall be fitted with depth gauges.

5-6.10 Where a drainage system incorporates permanently fixed pipework the bilge-bottom drainage pipes intended to extract oily water shall be equipped with closures that have been sealed in position by an inspection body. The number and position of those closures shall be entered on the certificate.

CHAPTER 6

ELECTRICAL INSTALLATIONS

6-1 GENERAL PROVISIONS

6-1.1 Definitions

Earthing. "Earthing" means electrical connection to the mass of the hull.

Hull return. The distribution of direct or alternating current is said to be of the "hull return" type when the insulated conductors are connected to one of the feed poles and the hull or superstructure is connected to the other pole.

Safe voltage. "Safe voltage" means a voltage presenting no danger to persons. This condition shall be deemed to be satisfied if the windings of transformers, converters and other voltage-reducing devices are electrically separate and the reduced voltage of such devices or the voltage of sources of electric power does not exceed 50 V between the poles in the case of direct current, or between phases in the case of alternating current.

6-1.2 General requirements

6-1.2.1 Where there are no specific requirements concerning certain parts of an installation the safety level shall be considered satisfactory where those parts have been produced in accordance with an approved European standard or in accordance with the requirements of an approved classification society. The relevant documents shall be submitted to the authorized inspection body.

6-1.2.2 The electrical and electronic equipment shall be designed for permanent lists of up to 15° and ambient inside temperatures of between 0 and +40°C, and on the deck between -20°C and +40°C. It shall function perfectly at those limits. The Administration may extend the outside temperature range in accordance with local climatic conditions.

6-1.2.3 The electrical and electronic equipment and appliances shall be fully accessible and easy to maintain.

6-1.3 Electrical supply systems

6-1.3.1 Where craft are fitted with an electric system that system shall have at least two power sources in such a way that where one power source fails the remaining source is able to supply the equipment needed for navigational safety for an appropriate period of time to be determined by the Administration of the river basin.

6-1.3.2 Adequate sizing of the power supply shall be demonstrated by means of a power balance. An appropriate simultaneity factor may be taken into account.

6-1.4 Documents required to be available on board

Documents containing the following, and duly stamped by the authorized inspection body, shall be kept on board:

- (a) a set of instructions for use and a description of the electrical installations;
- (b) wiring diagrams concerning all of the electrical equipment;
- (c) switching diagrams for the main control panel, the emergency-installation panel and the distribution panels, together with the most important technical data such as the amperage and rated current of the protection and control devices;
- (d) power data concerning the electrical service equipment;
- (e) types of cable and statement of conductor cross sections;
- (f) All other particulars essential for an assessment of safety.

It is not necessary to keep such documents on board uncrewed craft, but they must be available at all times from the owner.

6-2 TECHNICAL REQUIREMENTS

6-2.1 Maximum permissible voltages

6-2.1.1 The following voltages shall not be exceeded:

Type of installation	Maximum permissible voltage		
	Direct current	Single-phase alternating current	Three-phase alternating current
a. Power and heating installations including the relevant sockets	250 V	250 V	500 V
b. Lighting, communications, command and information installations, including the relevant sockets	250V	250V	-
c. Sockets intended to supply portable devices used on open decks or within narrow or damp metal lockers, apart from boilers and tanks:			
1. In general	50V	50V1)	-
2. Where a circuit-separation transformer only supplies one appliance	-	250V2)	-
3. Where protective-insulation (double insulation) appliances are used	250V	250V	-
4. Where <30 mA default current circuit breakers are used	-	250V	500V
d. Mobile components such as electrical equipment for containers, motors, blowers and mobile pumps which are not normally handled during service and use conducting parts which are open to physical contact are earthed by means of a protective conductor that is incorporated into the connecting cable and which, in addition to that effective conductor, are connected to the hull by their location or another conductor	250V	250V	500V
e. Sockets intended to supply portable appliances used inside boilers and tanks	50V1)	50V1)	
Comments:			
1) Where that voltage comes from higher-voltage networks galvanic separation must be used (safety transformer).			
2) All of the poles of the secondary circuit shall be insulated from the earth.			

6-2.3 Explosion proofing

Only electrical equipment that has been explosion proofed, (safety-certified) may be installed in premises where potentially explosive gases or mixtures of gases are likely to accumulate, such as compartments set aside for accumulators or the storage of highly inflammable products. No light switches or other electrical appliances shall be installed on those premises. The explosion proofing shall take account of the characteristics of the potentially explosive gases or mixtures of gases that are likely to arise (explosion-potential group, temperature class).

6-2.4 Distribution systems

6-2.4.1. The following distribution systems are allowed for direct and single-phase alternating current:

- (i) two-conductor systems of which one is earthed;
- (ii) single-conductor systems using the hull-return principle, only for local installations (for example, starting gear for combustion engines, cathodic protection);
- (iii) two-conductor systems that are insulated from the hull.

6-2.4.2 The following distribution systems are allowed for three-phase alternating current:

- (i) four-conductor systems with earthing of the neutral point, not using the hull return principle;
- (ii) three-conductor systems insulated from the hull;
- (iii) three-conductor systems with earthing of the neutral point using the hull return principle except for terminal circuits.

6-2.4.3 All such systems shall comply with the rules of the Administration or of a recognized Classification Society.

6-2.4.4 The use of other distribution systems shall be subject to the prior consent of the Administration.

6-2.4.5 Connection to the shore or other external networks

6-2.4.5.1 Incoming supply lines from land-based networks or other external networks to the installations of the onboard network shall have a permanent connection on board in the form of fixed terminals or fixed plug sockets. The cable connections shall not be subjected to any pulling load.

6-2.4.5.2 The hull shall be capable of being earthed effectively when the connection voltage exceeds 50 V. The earthing connection shall be specially marked.

6-2.4.5.3 The switching devices for the connection shall be capable of being locked so as to prevent the concurrent operation of the onboard network generators and the shore network or another external network. A brief period of concurrent operation shall be permitted when changing from one system to another without a break in voltage.

6-2.4.5.4 The connection shall be protected against short circuits and overloads.

6-2.4.5.5 The main switchboard shall indicate whether the connection is live.

6-2.4.5.6 Indicator devices shall be installed to enable polarity to be compared, in the case of direct current, and phase sequence in the case of alternating current, between the connection and the onboard network.

6-2.4.5.7 A panel on the connection shall indicate:

- (i) the measures required to make the connection;
- (ii) the types of current and the nominal voltage and, for alternating current, the frequency.

6-2.4.6 Special provisions for pushed convoys and other craft

6-2.4.6.1 The supply to the barges of the convoy shall be controlled by means of multiple switches installed on the pusher.

6-2.4.6.2 Instruction plates shall be affixed to current take-off devices and to craft-coupling devices, stipulating that feeders must be disconnected before barges are coupled or uncoupled.

6-2.4.6.3 When power is supplied to other craft, a separate connection shall be used. If power sockets rated at more than 16 A are used to supply current to other craft, steps shall be taken to ensure (for example, by the use of switches or interlocks) that connection and disconnection can take place only when the line is dead.

6-2.4.6.4 Cables and their connections shall not be subjected to any pulling load

6-2.4.6.5 Paragraphs 6-2.4.5.3 - 6-2.4.5.7 shall apply by analogy.

6-2.5 Generators and motors

6-2.5.1 Generators and motors shall be so installed as to be readily accessible for inspection, measurements and repairs and as to prevent water and oil from reaching the windings. Terminal boxes shall be readily accessible, amply dimensioned and sufficiently waterproof. The type of protection should be in accordance with the table in 6-2.2 above.

6-2.6 Accumulators

6-2.6.1 The accumulators shall be of a construction suitable for use on board a vessel. They shall be grouped in boxes or trays fitted with grips to facilitate handling. Cell boxes shall be made of a shock-resistant material that does not easily catch fire and shall be so made as to prevent any spillage of electrolyte at an inclination of 40° from the vertical.

6-2.6.2 Accumulators shall be so arranged as not to shift with the movements of the vessel. They shall not be exposed to excessive heat, extreme cold, spray, steam or vapour. Accumulator batteries shall be installed so as to permit easy access for replacement, topping up and cleaning of the elements, with a space of not less than 15 mm all around them to allow air to circulate, and with no more than 1.5 m. separating the deck from the plugs in the uppermost bank. If accumulators are installed on two or more shelves one above the other, at least 50 mm space shall be left at the front and back of each shelf to allow air to circulate.

Accumulator batteries shall not be installed in the wheelhouse, accommodation or holds.

This requirement shall not apply to accumulators for portable appliances, or to accumulators requiring a charging power of less than 0.2 kW.

6-2.6.3 Accumulator batteries requiring a charging power of more than 2 kW (calculated from the maximum charging current and the nominal voltage of the battery) shall be installed in a special battery room. If placed on deck, they shall be enclosed in a cupboard or chest.

Accumulator batteries requiring a charging power not exceeding 2 kW may be installed below decks in a cupboard or chest. They may be installed in the machinery space or any other well-ventilated place provided that they are protected against falling objects and dripping water.

Special battery rooms shall be capable of being heated when the temperature inside them falls below 5° C.

6-2.6.4 The interior surfaces of all battery rooms, including cupboards, lockers, shelving and other built-in fixtures, shall be protected against action of the electrolyte by a coat of paint or a lining made of a material resistant to the electrolyte.

6-2.6.5 Provision shall be made for effective ventilation when batteries are installed in a closed compartment, cupboard or chest. Forced-draught ventilation shall be provided for nickel-cadmium accumulators requiring a charging power of more than 2 kW and for lead-acid accumulators requiring more than 3 kW.

The air shall enter at the bottom and be discharged at the top so that the whole of the battery is swept by the air stream. Ventilation ducts shall not include devices which obstruct the air flow.

The minimum air throughput for ventilation, in m³/hour, shall be calculated by the following formula:

$$Q = 0.11 \cdot I \cdot n$$

where:

- I represents, in amperes, the maximum charging current (it shall be not less than one quarter of the maximum current admissible by the charging device);
- n represents the number of cells.

6-2.6.6 Where natural ventilation is used, the cross-section of the ducts shall be sufficient for the required air throughput at an air-flow velocity of 0.5 m/sec. It shall be not less than 80 cm² for lead batteries and not less than 120 cm² for alkaline batteries.

6-2.6.7 Where the required ventilation cannot be obtained by natural air flow, an exhaust fan shall be provided; its motor shall be clear of the gas stream.

Special devices shall be provided to prevent gases from entering the motor.

Fans shall be of a construction and material precluding the production of sparks through contact between a blade and the fan casing. In addition, the material shall be such as to dissipate any electrostatic charges. Warning signs prohibiting smoking and entry by persons carrying a naked flame shall be placed on the doors of rooms or cupboards, or the covers of chests, containing batteries.

6-2.7 Electrical switchboards

6-2.7.1 Switchboards shall be situated in accessible and well-ventilated places protected against gaseous or acid emissions. They shall be so arranged as to be protected against jolting and against the effects of weather, water, oil, liquid fuel, steam and vapour.

Switchboards shall not be placed near sounding pipes or near the vent pipes of liquid-fuel tanks.

No pressure pipes shall be situated above the main or emergency switchboard or the control panels of propulsion equipment. In vessels where this requirement cannot be met, no pipe joint shall be installed above an electrical switchboard.

6-2.7.2 In general, materials used in the construction of switchboards shall have suitable mechanical strength and be durable and non-inflammable. They shall not be hygroscopic.

6-2.7.3 Where the voltage exceeds the safe voltage:

- (i) The current-carrying components shall be so arranged or protected as to prevent accidental personal contact;
- (ii) An insulating mat or an impregnated wooden grating shall be provided; this shall not apply, however, to subdistribution panels;
- (iii) Metal parts of the frames or substructures of control devices and the metal casings of appliances shall be carefully earthed.

6-2.7.4 All parts of switchboards, including the connections, shall be readily accessible for inspection, maintenance or replacement.

6-2.7.5 Marker plates for all circuits shall be affixed to switchboards.

6-2.8 Switches, protective devices

6-2.8.1 Generator circuits and consumer circuits shall be protected against short circuits and overcurrent on all non-earthed conductors. Overload circuit-breakers or fuses may be used for this purpose. Circuits supplying the steering-gear motors (steering installations) and fire pumps and their control circuits shall only be protected against short circuits. Where circuits include thermal circuit-breakers these shall be neutralized or set at not less than twice the nominal amperage and fitted with an emergency warning light indicating overloading.

6-2.8.2 Outputs from the main switchboard to appliances operating at more than 16 A shall include a load or power switch.

6-2.8.3 Prime movers for the craft, the steering system, the rudder position indicator, navigation or safety systems, and appliances with a nominal amperage greater than 16 A shall be supplied by separate circuits.

6-2.8.4 The circuits of appliances required for propelling and manoeuvring the vessel shall be supplied directly by the main switchboard.

6-2.8.5 Circuit-breaking equipment shall be selected on the basis of nominal amperage, thermal or dynamic strength, and their breaking capacity. Switches shall simultaneously cut off all live conductors. The switching position shall be identifiable.

6-2.8.6 Fuses shall be of the enclosed-melt type and be made of porcelain or an equivalent material. It shall be possible to change them without any danger of operator contact.

6-2.9 Measuring and monitoring devices

6-2.9.1 Generator, battery and distribution circuits shall be equipped with measuring and monitoring devices where the safe operation of the installation so requires.

6-2.9.2 Non-earthed networks where the voltage is higher than 50 V, must include an earth-insulation checking device equipped with a visual and audible alarm. In secondary installations such as control circuits, this device may be dispensed with.

6-2.10 Emergency circuit breakers

Emergency circuit breakers for oil burners, fuel pumps, fuel separators and engine-room ventilators shall be installed outside the premises containing the equipment.

6-2.11 Fixed installations

6-2.11.1 Equipment seals shall be sized as a function of the cables to be connected and be appropriate to the types of cable used.

6-2.11.2 Sockets for distribution circuits at different voltages or frequencies shall be impossible to confuse.

6-2.11.3 Switches shall simultaneously switch off all unearthed conductors within a circuit. However, single-pole switches within unearthed circuitry shall be permitted in accommodation-lighting circuits apart from in laundries, bathrooms and washrooms.

6-2.11.4 Where amperage exceeds 16 A it shall be possible to lock the sockets by means of a switch in such a way that the plug can only be inserted and withdrawn with the power switched off.

6-2.12 Cables

6-2.12.1 Cables shall be flame-retardant, self-extinguishing and resistant to water and oil. In accommodation, other types of cable may be used, provided that they are effectively protected, have flame-retardant characteristics and are self-extinguishing.

6-2.12.2 Cables with conducting wires with a minimum cross-section of 1.5 mm² shall be used for power circuits and of 1.0 mm² for lighting circuits.

6-2.12.3 The armouring and metal sheathing of power and lighting circuits shall not, under normal operating conditions, be used as conductor wires or earth wires.

6-2.12.4 The armouring and metal sheathing of power and lighting circuits shall be earthed at least at one end.

6-2.12.5 The cross-section of conductor wires shall take account of the final permissible maximum temperature of conductor wires (maximum permissible amperage) and permissible voltage drop. Such a drop between the main switchboard and the furthest consumer on the circuit shall not be more than 5% of nominal voltage for lighting or more than 7% for power or heating circuits.

6-2.12.6 Cables shall be protected against mechanical damage.

6-2.12.7 The means of fixing the cables shall ensure that any pulling load remains within the permissible limits.

6-2.12.8 When cables pass through partitions or decks, the mechanical strength, watertightness and fire resistance of these partitions and decks shall not be affected by the seals.

6-2.12.9 Cables linking mobile wheelhouses shall be sufficiently flexible and be fitted with insulation with sufficient flexibility down to -20°C and resistance to steam and vapour, ultraviolet rays, ozone, etc.

6-2.13 Lighting

6-2.13.1 In spaces in which accumulators are installed or paint and other highly inflammable substances are stored, limited-explosion-risk lighting appliances shall be used.

6-2.13.2 Lighting appliances shall be so installed that the heat they emit cannot set fire to nearby inflammable objects or components.

6-2.13.3 Lighting appliances on open decks shall be so installed as not to impede the recognition of signal lights.

6-2.13.4 When two or more lighting appliances are installed in an engine-, or boiler-rooms, they shall be supplied by at least two different circuits. This requirement shall also apply to spaces where cooling or hydraulic machinery, or electric motors, are installed.

6-2.14 Signal lights

6-2.14.1 The switchboards for the signal lights shall be installed in the wheelhouse. They shall be supplied by a separate feeder from the main switchboard or by two separate secondary networks.

6-2.14.2 Lights shall be individually supplied from the lighting panel and be individually protected and controlled.

6-2.14.3 Tell-tale lamps or other equivalent devices monitoring the signal lights shall be placed on the switchboard in the wheelhouse unless direct monitoring from the wheelhouse is possible. No fault in the monitoring installation shall affect the operation of the light which it monitors.

6-2.14.4 Several lights forming a functional unit and installed together at the same point may be jointly supplied, controlled and monitored. The monitoring installation shall be capable of identifying the failure of any of these lights. However, it shall not be possible to use both light sources in a double light (two lights mounted one above the other or in the same housing) simultaneously.

6-2.15 Earthing

6-2.15.1 Systems under a voltage of more than 50 V need to be earthed.

6-2.15.2 Metal parts that are open to physical contact and which, during normal operation, are not electrically live, such as engine frames and casings, appliances and lighting equipment, shall be earthed separately where these are not in electrical contact with the hull as a result of their installation.

6-2.15.3 The housings of electrical receivers of the mobile and portable type shall be earthed by means of an additional conductor which is out of tension during normal use and is incorporated into the power cable.

6-2.15.4 That prescription does not apply where a circuit-separation transformer is used, nor to appliances fitted with protective insulation (double insulation).

6-2.15.5 The cross section of the earthing conductors shall be not less than as set out in the table below:

Cross section of outside conductors (mm ²)	Minimum cross section of earthing conductors	
	in insulated cables (mm ²)	fitted separately (mm ²)
from 0.5 to 4	same cross section as that of the outside conductor	4
more than 4 to 16	same cross section as that of the outside conductor	same cross section as that of the outside conductor
more than 16 to 35	16	16
more than 35 to 120	half of the cross section of the outside conductor	half of the cross section of the outside conductor
more than 120	70	70

6.2.16 Emergency source of electric power

6-2.16.1 (i) Every vessel navigating in zone 1 shall be equipped with an emergency source of electric power.

(ii) Every passenger vessel navigating in zones 2 and 3 shall be equipped with an emergency source of electric power.

The Administration may prescribe more detailed requirements concerning emergency source of electric power, depending on the type and purpose of the vessel.

6-2.16.2 If a vessel navigating in zones 2 and 3, other than a passenger vessel not less than 25 m in length, is equipped with two or more independent sources of power, one of them may be accepted as an emergency source of power.

6-2.16.3 The emergency source of power may be:

(i) Either an auxiliary set whose fuel supply system and cooling system are independent of the main machinery, and which is automatically started and connected to the network as soon as the voltage falls on the bus-bars of the main switchboard. The electric power shall be supplied within 30 seconds after the failure of the main electricity supply. The Administration or a recognized Classification Society may permit manual starting if the auxiliary set is installed in the immediate vicinity of a station which is permanently manned and which is outside the machinery space;

(ii) Or an accumulator battery automatically taking up current-supply duty in a network failure and capable of meeting the requirements of paragraph 6-2.16.4 for the prescribed time without having to be recharged and without a voltage drop exceeding

that authorized. The Administration or a recognized Classification Society may permit manual switching on from a station which is permanently manned and which is outside the machinery space.

On passenger vessels, power for emergency lighting shall be supplied within seven seconds.

6-2.16.4 The emergency source and its switchboard shall be installed:

- (i) On vessels navigating in zone 1, above the freeboard deck and outside the machinery space;
- (ii) On passenger vessels navigating in zones 2 and 3, outside the machinery space. If the vessel is less than 25 m in length, the emergency source may be installed in the machinery space, as high up as possible.
- (iii) On all other vessels navigating in zones 2 and 3, as high up as possible.

If the space housing the emergency source is situated below the freeboard deck, that space shall be accessible from the deck. On passenger vessels not less than 25 m in length, the space housing the emergency source shall be enclosed by watertight and fire-resistant decks and watertight and fire-resistant bulkheads.

The emergency source of power shall not be installed forward of the collision bulkhead.

6-2.16.5 The capacity of the emergency source shall be sufficient to supply all consumers necessary to the safety of all persons on board, due account being taken of consumers which may be required to operate simultaneously. At least the following, if their use is prescribed, and if they each have no independent emergency source of power, shall be supplied simultaneously

- (i) Navigation and signal lights;
- (ii) Emergency lighting;
- (iii) Alarm and safety systems;
- (iv) Intercommunication systems;
- (v) Radio and telephone equipment;
- (vi) Emergency floodlight;
- (vii) Controls of fixed fire-fighting installations;
- (viii) Fire pump and emergency pump (on passenger vessels);
- (ix) Emergency steering gear.

The length of time for which the emergency source of power shall be required to supply the prescribed consumers shall be fixed according to the vessel's purpose, but shall not be less than 30 minutes.

6-2.16.6 At least the following places and stations shall be provided with sufficient emergency lighting:

- (i) Places where collective life-saving appliances are stored, handled and launched;
- (ii) Accommodation exists and passages;
- (iii) Machinery spaces and their exits;
- (iv) The emergency switchboard;
- (v) The wheelhouse (with provision for disconnection);
- (vi) The space housing the emergency source of power;
- (vii) Fire-fighting stations;
- (viii) Emergency assembly stations for passengers and crew.

The intensity of the emergency lighting shall be prescribed by the Administration.

6-2.17 Alarm and safety systems

The alarm and safety systems for monitoring and protecting mechanical equipment shall meet the following requirements:

6-2.17.1 Alarm systems

The alarm systems shall be so designed that no failure in the alarm system can result in failure of the apparatus or equipment being monitored. Binary transmitters shall be designed on the quiescent-current principle or on the monitored load-current principle. Visual alarms shall remain visible until the fault has been remedied; an alarm with acknowledgement shall be distinguishable from an alarm without acknowledgement. Each alarm shall also comprise an audible warning. It shall be possible to switch off acoustic alarms. Switching off one acoustic alarm shall not prevent another signal from being set off by another cause. Exceptions shall be permitted in the case of alarm systems comprising less than 5 measurement points.

6-2.17.2 Safety systems

Safety systems shall be designed to halt or slow down the operation of the affected equipment, or to warn a permanently-manned station to do so before a critical state is reached. Binary transmitters shall be designed according to the load-current principle. If safety systems are not designed to be self-monitoring their operation must be checkable. Safety systems must be independent of other systems.

6-2.18 Electronic equipment

6-2.18.1 General

The test conditions in 2 below shall apply only to electronic devices and their ancillaries on the steering system and the craft's power plants.

6-2.18.2 Test conditions

(i) The stresses arising from the test shall not cause electronic devices to be damaged or to malfunction. The tests in accordance with the international standards, such as publication IEC 92-504 concerning these, shall be carried out with the device in operation, apart from the cold-proofing test;

(ii) Variations in voltage and frequency

	Value for service	Variations	
		continuous	short-duration
General	Frequency	+ 5%	+ 10% 5 s
	Voltage	+ 10%	+ 20% 1.5 s
Battery operation	voltage	+ 30% / - 25%	-

(iii) Heating test

The sample is brought up to a temperature of 55°C within a half-hour period. After that temperature has been achieved it is maintained for 16 hours. An operating test is then conducted.

(iv) Cold-condition test

The sample is shut down and cooled to -25°C and held at that temperature for two hours. The temperature is then raised to 0°C and an operating test is conducted.

(v) Vibration test

The vibration test shall be carried out along the three axes at the resonance frequency of the appliances or parts for the period of 90 minutes in each case. If no clear resonance emerges the vibration test takes place at 30 Hz. The vibration test takes place via sinusoidal oscillation within the following limits:

General:

$$f = 2.0 - 13.2 \text{ Hz}; a = \pm 1 \text{ mm}$$

(amplitude $a = 1/2$ the vibration width)

$$f = 13.2 \text{ Hz} - 100 \text{ Hz}; \text{ acceleration } \pm 0.7 \text{ g}.$$

Equipment intended to be fitted to diesel engines or steering system shall be tested as follows:

$$f = 2.0 - 25 \text{ Hz}; a = \pm 1.6 \text{ mm}$$

(amplitude $a = 1/2$ the vibration width)

$$f = 25 \text{ Hz} - 100 \text{ Hz}; \text{ acceleration } \pm 4 \text{ g} .$$

The sensors intended to be installed in diesel-engine exhaust pipes may be exposed to considerably higher stresses. Account shall be taken of this during the tests.

- (vi) The electromagnetic compatibility test shall be carried out on the basis of IEC publications 801-2, 801-3, 801-4, 801-5 at test degree number 3.
- (vii) Proof that the electronic equipment is adequate for these test conditions shall be provided by their manufacturer. A certificate by a Classification Society is likewise considered to be proof.

6-2.19 Electromagnetic compatibility

The operation of the electric and electromagnetic systems shall not be impaired by electromagnetic interference. General accompanying measures shall concentrate on:

- (i) disconnection of the transmission paths between the source of interference and the user appliances;
- (ii) reducing the causes of disturbance at their source;
- (iii) reducing the sensitivity of the consumer appliances.

CHAPTER 7

HOISTING GEAR, RIGGING AND EQUIPMENT

7-1 MASTS FITTED WITH HOISTING GEAR

7-1.1 Masts for supporting derricks shall be made of standardized material or materials approved by a recognized Classification Society.

7-1.2 The masts shall be suitably fixed to the vessel and shall be built to adequate scantlings, account being taken of the maximum load on the derricks they are intended to support.

7-2 DERRICKS AND OTHER HOISTING GEAR

7-2.1 Hoisting gear (including masts and derricks) and all fixed or movable fittings used on board for loading or unloading shall comply with the requirements of the Convention concerning Occupational Safety and Health in Dock Work 1979 (Convention No. 152) adopted by the International Labour Office.

7-2.2 Hoisting gear other than mentioned in 7-2.1 shall meet the requirements of the Administration.

7-3 MISCELLANEOUS EQUIPMENT

7-3.1 All manned vessels shall be provided with at least the following equipment:

- The appliances and devices needed for the emission of visual and acoustic signals and for marking the vessel;
- Spare lamps for the navigation lights or an emergency power source for the navigation lights;
- A pair of ship's binoculars;
- A loud-hailer;
- A gangway at least 0.4 m wide and 4 m long, fitted with a hand-rail; the inspection body may permit shorter gangways for small vessels;
- A sounding device;
- A boathook;
- A suitable equipment for stopping minor leaks;
- A first-aid kit;
- A notice concerning the rescue of men overboard;
- Two heaving-lines;
- Radio telephone system.

7-3.2 In addition to the requirements of 7-3.1, manned vessels navigating in zone 2 shall be provided with:

- A fixed compass;
- Availability of nautical charts.

An echo sounder or a sounding lead.

7-3.3 In addition to the requirements of 7-3.1 and 7-3.2 manned vessels navigating in zone 1 shall be provided with:

- Spare lamps for the navigation lights;
- A radio set for receiving weather reports;
- A chronometer at the helmsman's^{4/} station;
- A pilot-ladder;
- Covers for windows, skylights and other openings which may let in water.

^{4/} Note by the secretariat: It is suggested to use the terms "steering station" in English, "poste de gouverne" in French (used in original text of RVBR) and "rulevoy post" in Russian (see also TRANS/SC.3/WP.3/2004/1, article 9(1)(a)).

CHAPTER 9

LIQUIFIED GAS INSTALLATIONS FOR DOMESTIC PURPOSES

9-1 GENERAL

9-1.1 Every gas installation shall consist essentially of one or more gas receptacles, one or more pressure reducers, a distribution system and a number of gas-consuming appliances.

9-1.2 Such installations may be operated only with the gas mixture of which the customary name is propane.^{5/}

9-2 INSTALLATION

9-2.1 Gas installations shall, in all their parts, be suitable for the use of propane and shall be built and installed in accordance with the state of the art.

9-2.2 A gas installation may be used only for domestic purposes in spaces that comply with the requirements of the Administration.

9-2.3 There may be several separate gas installations on board. Accommodation areas separated by a cargo hold or a fixed tank shall not be supplied by the same installation.

9-2.4 Installations which are not permanently fixed may be used only if they meet the special requirements laid down by the Administration.

9-3 RECEPTACLES

9-3.1 Only receptacles with a capacity of between 5 and 35 kg shall be allowed. In the case of passenger vessels, the basin Administration may approve the use of receptacles with a larger content.

9-3.2 The receptacles shall satisfy the requirements in force. They shall bear the official stamp certifying that they have passed the statutory tests.

9-4 LOCATION AND ARRANGEMENT OF THE SUPPLY UNIT

9-4.1 The supply unit shall be installed on deck in a special cupboard located outside the accommodation area in such a position that it does not interfere with movement on board. It shall not, however, be installed against the forward or after bulwark plating. The cupboard may be a wall cupboard set into the superstructure provided that it is gastight and can only be opened from outside. It shall be so located that the pipes leading to the gas consumption points are as short as possible.

Each installation may have up to four receptacles in operation simultaneously, with or without the use of an automatic changeover valve. The number of receptacles on board, including spare receptacles, shall not exceed six per installation.

^{5/} Gas mixture defined in ADN, annex A, marginal 6201, 2° F as mixture C.

On passenger vessels having galleys or canteens for the passengers, up to six receptacles per installation may be in operation simultaneously, with or without the use of an automatic changeover valve. The number of receptacles on board such vessels, including spare receptacles, shall not exceed nine per installation.

The pressure reducer or, in the case of two-stage reduction, the first pressure reducer shall be fitted to the inside wall of the cupboard for the receptacles.

9-4.2 The supply unit shall be so installed that any leaking gas can escape from the cupboard without any risk that it may penetrate the vessel or come into contact with any possible source of ignition.

9-4.3 The cupboard shall be constructed of fire-resistant materials and shall be adequately ventilated by openings at the top and bottom. The receptacles shall be placed upright in the cupboard in such a way that they cannot overturn.

9-4.4 The cupboard shall be so constructed and situated that the temperature of the receptacles cannot exceed 50 °C.

9-4.5 The words “liquefied gas” and “no smoking” symbol at least 100 mm in diameter shall be affixed to the outer wall of the cupboard.

9-5 SPARE AND EMPTY RECEPTACLES

9-5.1 Spare and empty receptacles which are not stored in the supply unit shall be stored outside the accommodation area and the wheelhouse in a cupboard constructed in accordance with the requirements of section 9-4, paragraphs 9-4.2 to 9-4.5.

9-6 PRESSURE REDUCERS

9-6.1 The gas-consuming appliances may be connected to the receptacles only through a distribution system fitted with one or more pressure reducers to bring the gas pressure down to the working pressure. The pressure may be reduced in one or two stages. All pressure reducers shall be set permanently at a pressure determined in accordance with section 9-7 below.

9-6.2 The final pressure reducer shall be either fitted with or followed by a device to protect the piping automatically against excess pressure in the event of a malfunction of the pressure reducer. Any gas which this protection device allows to escape shall be evacuated into the open air without any risk that it may penetrate the vessel or come into contact with any possible source of ignition; if necessary a special vent shall be fitted for this purpose.

9-6.3 The safety devices and the vents shall be protected against ingress of water.

9-7 PRESSURE

9-7.1 The pressure at the outlet of the final pressure reducer shall not be more than 5 kPa above atmospheric pressure, with a tolerance of 10%.

9-7.2 In the case of two-stage reduction, the intermediate pressure shall not be more than 250 kPa above atmospheric pressure.

9-8 PIPING AND FLEXIBLE TUBES

9-8.1 The piping shall consist of fixed steel or copper tubing.

The pipes connected to the receptacles, however, shall consist of high pressure flexible tubing or spiral tubes suitable for the gas used. The gas consuming appliances may, if they are not installed as fixtures, be connected up by means of suitable flexible tubes not more than 1 m long.

9-8.2 The piping shall be able to withstand all influences to which it may be subjected under normal operating conditions on board, in particular corrosion and stresses, and its characteristics and layout shall be such that it ensures a satisfactory flow of gas at the appropriate pressure to the gas consuming appliances.

9-8.3 The piping shall include as few joints as possible. The piping and the joints shall be gastight and shall remain gastight despite any vibration or expansion to which they may be subjected.

9-8.4 The piping shall be readily accessible, properly fixed and protected at every point where it might be subjected to impact or friction, particularly where it passes through metal bulkheads or other metal partitions.

The entire outer surface of steel piping shall be treated against corrosion.

9-8.5 Flexible pipes and their joints shall be able to withstand any stresses which may occur under normal operating conditions on board. They shall be fitted without load and in such a way that they cannot be overheated and can be inspected throughout their length.

9-9 DISTRIBUTION SYSTEM

9-9.1 No part of a gas installation shall be situated in the machinery space.

9-9.2 It shall be possible to shut off the entire distribution system by means of a valve which is readily and quickly accessible.

9-9.3 Each gas-consuming appliance shall be supplied by a separate branch of the distribution system, and each such branch shall be controlled by a separate closing device.

9-9.4 The valves shall so far as possible be protected from the weather and against impact.

9-9.5 The ends of pipes intended for connection to gas-consuming appliances shall be closable by a flange or cap even if they are equipped with a shut-off valve.

9-9.6 An inspection joint shall be fitted after each pressure reducer. It shall be ensured, using a closing device, that in pressure tests the pressure reducer is not exposed to the test pressure.

9-10 GAS-CONSUMING APPLIANCES AND THEIR INSTALLATION

9-10.1 The only consuming appliances that may be installed shall be those which have been approved by the Administration and which are equipped with devices that effectively prevent the escape of gas in case of extinction either of the burner or of the pilot flame.

9-10.2 Each appliance shall be so placed and connected as to avoid any risk that the connecting piping may be accidentally wrenched loose.

9-10.3 The installation of gas-consuming appliances in the wheelhouse shall be permitted only if the wheelhouse is so constructed that no leaking gas can escape into the lower parts of the vessel.

9-10.4 Gas-consuming appliances may be installed in sleeping rooms only if the combustion process does not depend on the ambient air.

9-10.5 Gas-consuming appliances in which the combustion process depends on the ambient air shall be installed only in rooms of sufficient size.

9-11 VENTILATION AND EVACUATION OF THE COMBUSTION GASES

9-11.1 Heating and water-heating appliances and refrigerators shall be connected to a duct for evacuating combustion gases into the open air.

9-11.2 In spaces containing gas-consuming appliances in which the combustion process depends on the ambient air, the supply of fresh air and the evacuation of the combustion gases shall be ensured by means of apertures of adequate dimensions determined according to the capacity of the appliances, with a clear section of at least 150 cm² per aperture.

9-11.3 The ventilation apertures shall not have any closing device and shall not lead into sleeping rooms.

9-11.4 The evacuation devices shall be such as to ensure reliable and effective evacuation of the combustion gases. They shall be fire-resistant and their effectiveness shall not be impaired by the room ventilators.

9-12 INSTRUCTIONS FOR USE AND SAFETY

9-12.1 A notice containing instructions on the use of the installation shall be affixed on board in a suitable place. The notice shall bear, in particular, the following instructions:

"The valves of receptacles which are not connected to the distribution system shall be closed even if the receptacles are presumed to be empty."

"Flexible pipes shall be renewed as soon as their condition so requires."

"All receptacles shall be kept connected up unless the corresponding connecting pipes are closed by valves or sealed."

9-13 INSPECTION

9-13.1 Before a gas installation is put into service, after any modification or repair and at each renewal of the entry referred to in section 9-15 below, the whole of the installation shall be submitted to an expert recognized by the Administration for inspection. At the time of the inspection, the expert shall check whether the installation complies with the requirements of this chapter.

The expert shall submit a report to the competent authority of the Administration.

9-14 TESTS AND TRIALS

The completed installation shall be subjected to the following tests and trials:

9-14.1 Medium-pressure piping between the first pressure reducer and the valves upstream of the final pressure reducer:

- (i) Strength test, carried out with air, an inert gas or a liquid at a pressure prescribed by the Administration. This pressure shall not be less than 2 MPa above atmospheric pressure;
- (ii) Gastightness test, carried out with air or an inert gas at a pressure of 350 kPa above atmospheric pressure.

9-14.2 Piping at the working pressure between the single or final pressure reducer and the valves upstream of the gas-consuming appliances:

Gastightness test, carried out with air or an inert gas at a pressure of 100 kPa above atmospheric pressure.

9-14.3 Piping situated between the single or final pressure reducer and the controls of the gas-consuming appliance:

Gastightness test at a pressure of 20 kPa above atmospheric pressure.

9-14.4 In the tests referred to in paragraph 9-14.1 (ii), 9-14.2 and 9-14.3, the piping shall be considered gastight if, after sufficient time has elapsed for thermal balancing, no drop in the test pressure is noted during the following 10 minutes.

9-14.5 Receptacle connectors, piping and other fittings subjected to the pressure in the receptacles, and joint between the pressure reducer and the piping:

- (i) Strength test, carried out with air, an inert gas or liquid at the pressure prescribed by the Administration but in any case not less than 2.5 MPa above atmospheric pressure;
- (ii) Gastightness test, carried out with a foam-producing product at the working pressure.

9-14.6 All gas-consuming appliances shall, on being put into service, be tested at the working pressure to ensure that combustion is satisfactory with the controls in the different positions.

The safety devices shall be checked to ensure that they work properly.

9-14.7 After the test referred to in paragraph 9-14.6 above, trials shall be carried out with every gas-consuming appliance connected to a flue to check whether, after five minutes' operation at full capacity, with windows and doors closed and the ventilation devices in operation, any combustion gases are escaping through the damper.

If combustion gases are escaping otherwise than sporadically, the cause shall immediately be sought and eliminated. The appliance shall not be approved until all defects have been corrected.

9-15 ENTRY IN THE APPROPRIATE VESSEL'S PAPER

9-15.1 For every gas installation, the appropriate vessel's paper shall contain an entry stating that the installation complies with the requirements of this chapter.

9-15.2 This entry shall be made by the competent authority of the Administration following the inspection referred to in section 9-13 above.

9-15.3 The entry shall be valid for a period not exceeding three years and may be renewed only after another inspection has been carried out in accordance with section 9-13.

At the request of the owner of the vessel, accompanied by a statement of his reasons for making the request, the Administration may extend the validity of the entry by not more than three months without carrying out the inspection referred to in section 9-13 above. Such extension shall be granted in a written document which shall be kept on board the vessel. Such extension shall not affect the date of the next scheduled inspection.

CHAPTER 10 A

STEERING GEAR

10A-1 DEFINITIONS

10A-1.1 Steering gear: all the equipment necessary for steering the vessel, such as to ensure the manoeuvrability laid down in chapter X.

10A-1.2 Rudder: the rudder or rudders, with shaft, including the rudder quadrant and the components connecting with the steering apparatus.

10A-1.3 Steering apparatus: the part of the steering gear which produces the movement of the rudder.

10A-1.4 Drive unit: the steering-apparatus control, between the power source and the steering apparatus.

10A-1.5 Power source: the power supply to the steering control and the steering apparatus produced by an on-board network, batteries or an internal combustion engine.

10A-1.6 Steering control: the component parts of and circuitry for the operation of a power-drive unit;

10A-1.7 Steering apparatus control unit: the control for the steering apparatus, its drive unit and its power source.

10A-1.8 Manual drive: a system whereby manual operation of the hand wheel, moves the rudder by means of a mechanical or hydraulic transmission, without any additional power source.

10A-1.9 Manually-operated hydraulic drive: a manual control actuating a hydraulic transmission.

10A-1.10 Rate-of-turn regulator: equipment which automatically produces and maintains a given rate of turn of the vessel in accordance with preselected values.

10A-2 GENERAL REQUIREMENTS

10A-2.1 Vessels shall be equipped with steering gear which ensures at least the manoeuvrability prescribed in chapter X.

10A-2.2 The steering gear shall be so constituted that the rudder position cannot change unexpectedly.

10A-2.3 The entire steering gear shall be designed for a permanent list up to 15°, an angle of trim up to 5° and ambient temperatures from - 20° C to + 40° C.

10A-2.4 The component parts of the steering gear shall be rugged enough always to be able to withstand the stresses to which they may be subjected during normal operation. No external forces applied to the rudder shall impair the operating capacity of the steering equipment and its controls.

10A-2.5 The steering gear shall comprise a power-driven unit if the forces required to activate the rudder require so.

10A-2.6 The power-driven unit of the steering gear shall be protected against overload.

10A-2.7 Shaft bushings shall be so designed as to prevent any leakage of water-polluting lubricants.

10A-3 STEERING APPARATUS CONTROL UNIT

10A-3.1 If the steering gear has a power-driven unit, in case of the failure or breakdown of the steering apparatus control unit, it shall be possible to bring a second unit or a manual drive into service within five seconds.

10A-3.2 If the second steering apparatus control unit or manual drive is not automatically brought into service, it shall be possible for the helmsman to bring it into service simply and rapidly by means of a single manipulation.

10A-3.3 The second drive unit or manual drive shall ensure the manoeuvrability prescribed in Chapter X.

10A-4 HYDRAULIC DRIVE UNIT

10A-4.1 No consumer appliance may be connected to the hydraulic drive unit of the steering gear.

10A-4.2 If there are two hydraulic drive units a hydraulic tank is required for each of them; double tanks, however, are permitted. The hydraulic tanks shall be equipped with an oil low level indicator with alarm.

10A-4.3 The dimensions, construction and arrangement of the piping shall ensure as far as possible that they will not be damaged by mechanical effects or fire.

10A-4.4 Hoses are only permitted when their use is indispensable to absorb vibrations and permit the freedom of movement of the constituent parts. They shall be rated at least according to the maximum working pressure.

10A-5 POWER SOURCE

10A-5.1 If the steering gear is equipped with two power-driven units it shall have two power sources.

10A-5.2 If the second power source for the power-driven unit is not permanently available while the vessel is under way, a buffer device is required. Its capacity shall be sufficient to provide power during the period needed for bringing the second power source into operation.

10A-5.3 In the case of electrical power sources no other consumers may be powered by the network supplying the steering gear.

10A-6 MANUAL DRIVE

10A-6.1 The hand wheel shall not be actuated by the power-driven unit.

10A-6.2 Regardless of rudder position hand wheel kickback must be prevented when the manually-operated wheel is engaged automatically.

10A-7 RUDDER-PROPELLER, WATER-JET, CYCLOIDAL-PROPELLER, AND ACTIVE BOW-RUDDER SYSTEMS ^{6/}

10A-7.1. In the case of rudder-propeller, water-jet, cycloidal-propeller or active bow-rudder installations where the remote control of the modification of the direction of the drive is electric, hydraulic or pneumatic, there shall be two steering apparatus control units independent of each other, between the wheelhouse and the installation, and on analogy, meet the requirements of paragraphs 10A-2 to 10A-6.

Such systems are not subject to this section if they are not necessary in order to achieve the manoeuvrability required by chapter X or if they are only needed for the stopping test.

10A-7.2 Where there are several rudder-propeller, water-jet, cycloidal-propeller or bow-rudder systems that are independent of each other the second steering apparatus control unit is not necessary if the vessel retains the manoeuvrability required by chapter X if one of the units fails.

10A-8 INDICATORS AND MONITORING DEVICES

10A-8.1 The rudder position shall be clearly displayed at the steering position. If the rudder-position indicator is electrical it shall have its own power supply.

10A-8.2 There shall be at least the following indicators and monitoring devices at the steering position:

- (a) oil level in the hydraulic tanks in accordance with paragraph 10A-4.2, and working pressure of the hydraulic system;
- (b) failure of the electrical supply for the steering control;
- (c) failure of the electrical supply for the drive unit;
- (d) failure of the rate-of-turn regulator;
- (e) failure of the required buffer devices.

^{6/} Note by the secretariat: It is suggested to translate the term "bouteurs actifs" as "active bow rudders" in English and "aktivnye nosovye ruli" in Russian (see also footnote No. 11 below).

10A-9 RATE-OF-TURN REGULATORS

10A-9.1 The rate-of-turn regulators and their components shall meet the requirements laid down in paragraph 6 – 2.18.

10A-9.2 The proper functioning of the rate-of-turn regulator shall be displayed at the steering position by means of a green warning light.

Any lack of or unacceptable variations in the supply voltage and an unacceptable fall in the speed of rotation of the gyroscope shall be monitored.

10A-9.3 Where, in addition to the rate-of-turn regulator, there are other steering control systems, it shall be possible to distinguish clearly at the steering position which of these systems has been activated. It shall be possible to shift from one system to another immediately. The rate-of-turn regulator shall not cause any kickback in the steering systems.

10A-9.4 The electrical supply to the rate-of-turn regulator shall be independent of that for the other power consumers.

10A-9.5 The gyroscopes, detectors and rate-of-turn indicators used in the rate-of-turn regulators shall meet the minimum requirements and test conditions concerning rate-of-turn indicators for inland waterways as set by the competent authority.

10A-10 APPROVAL

10A-10.1 The compliance of the installed steering system shall be checked by a competent authority on the inspection of vessels. It may, for this purpose, request the following documents:

- (a) description of the steering gear;
- (b) drawings and information on the steering apparatus control units;
- (c) information concerning the steering apparatus;
- (d) electrical wiring diagram;
- (e) description of the rate-of-turn regulator;
- (f) system-use instructions.

10A-10.2 Operation of the entire steering gear shall be checked by means of a navigation test. It shall be checked that a predetermined course can be reliably maintained by the rate-of-turn regulators and that bends can be negotiated safely.

CHAPTER 10B

WHEELHOUSE

10B-1 GENERAL REQUIREMENTS

10B-1.1 It shall be possible to control and monitor propelling machinery and steering gear from the wheelhouse ^{7/}. Propelling machinery fitted with a clutch which can be operated from the wheelhouse ^{7/} or actuating a rudder propeller which can be operated from the wheelhouse ^{7/} may be started and stopped only from the engine room.

10B-1.2 Every engine shall be controlled by a single lever moving through the arc of a circle in a vertical plane more or less parallel to the longitudinal axis of the vessel. Forward movement of the lever shall cause the vessel to move forward and movement of the lever towards the stern shall cause the vessel to move astern. Engaging and reversing the engine shall be carried out by the lever. The neutral position of the lever shall be indicated by a perceptibly distinguishable click or by a perceptibly distinguishable marking. The sweep of the lever from the neutral position to the "full speed ahead" position and from the neutral position to the "full speed astern" position shall not exceed 90°.

10B-1.3 The wheelhouse shall be equipped with adjustable heating and ventilation systems. The wheelhouse darkening device shall not interfere with ventilation.

10B-1.4 The glazing used in wheelhouses shall display a light transmission of at least 75%.

10B-1.5 Under normal operating conditions, the sound-pressure level of the noise produced by the vessel shall not exceed 70 dB (A) at the helmsman's head position. However, the Administration may authorize a sound-pressure level of 75 dB (A) at the helmsman's head position for vessels not more than 30m in length, with the exception of pushers.

10B-1.6 Tell-tale lamps or any other equivalent device for monitoring the signal lights shall be installed in the wheelhouse unless that monitoring can be performed direct from the wheelhouse.

10B-2 UNOBSTRUCTED VIEW

10B-2.1 The view from the helmsman's station ^{8/} shall be sufficiently unobstructed in all directions.

10B-2.2 A sufficiently unobstructed view in all directions from the helmsman's station ^{2/} shall be deemed to be provided if the following conditions are met:

^{7/} Note by the secretariat: See footnote 4 to paragraph 7-3.3 above.

^{8/} Note by the secretariat: See footnote 4 to paragraph 7-3.3 above.

^{2/} Note by the secretariat: See footnote 4 to paragraph 7-3.3 above.

- (i) The unobstructed field of view from the helmsman's position shall cover at least 240° of the horizon, including at least 140° in the forward half-circle;
- (ii) No window frames, posts, etc. shall be placed in the helmsman's normal line of vision;
- (iii) The view through the windows in the helmsman's normal line of vision shall be kept clear under all weather conditions (rain, snow, frost) by suitable devices;
- (iv) If, in spite of the field of view of 240° or more, the sufficiently unobstructed view cannot be ensured astern, the competent authority on the inspection of vessels may require other measures to be taken, such as the installation of auxiliary optical devices.

10B-2.3 The dead area of vision forward of the bow of the unloaded vessel shall not extend beyond 250 m. The use of optical devices to reduce the dead area shall be left out of consideration for the purposes of this requirement.

10B-3 REQUIREMENTS CONCERNING CONTROL, DISPLAY AND MONITORING EQUIPMENT

10B-3.1 The controls shall move easily into the operating position, which shall be unmistakably clear.

10B-3.2 Monitoring instruments shall be easy to read whatever the lighting conditions inside the wheelhouse. Their illumination shall be capable of continuous adjustment to the point of extinction, so that the illumination is not dazzling and at the same time there is no impairment of visibility.

10B-3.3 There shall be a system for testing the warning lights.

10B-3.4 It shall be possible clearly to establish whether a system is in operation. If its functioning is indicated by means of a warning light the latter shall be green.

10B-3.5 Any malfunctioning or failure of systems that require monitoring shall be indicated by means of red warning lights.

10B-3.6 An audible warning shall sound at the same time that the red warning lights light up. The audible warnings may consist of a single, common signal. The sound pressure level of that signal shall exceed the maximum sound pressure level of the ambient noise at the steering position ^{10/} by at least 3 dB(A).

10B-3.7 The audible warning system may be switched off after the malfunction or failure has been confirmed. That shutdown shall not prevent the alarm signal from being triggered by other malfunctions. The red warning lights shall only go out when the malfunction has been corrected.

^{10/}

Note by the secretariat: See footnote 4 to paragraph 7-3.3 above.

10B-3.8 The monitoring and display devices shall be automatically connected to an alternative power supply if the main power supply fails.

10B-3.9 Devices for the remote control of the steering gear as a whole shall be installed permanently and so that the heading selected is clearly visible. If the remote control devices can be disengaged, they shall be fitted with an indicator showing whether the device is "in use" or "not in use". The arrangement and the manipulation of the controls shall be functional. Impermanent remote-control equipment for systems that are subsidiary to the steering system, such as active bow thrusters ^{11/}, shall be acceptable provided that such a subsidiary installation can be activated by means of an override at any time within the wheelhouse.

10B-4 RADAR EQUIPMENT AND RATE-OF-TURN CONTROL

10B-4.1 The radar equipment and rate-of-turn indicators must be of types that have been approved by the competent authorities. The requirements of the competent authority concerning installation and operational monitoring shall be met.

10B-4.2 The radar indicator must be located in such a way as to permit the boatmaster to monitor the situation around the vessel on the indicator and to control the vessel from his post. The distance from the vessel's steering station ^{12/} to the radar indicator shall not exceed 800 mm.

10B-4.3 Cordless remote control panels for radar equipment are not permitted.

10B-4.4 The radar equipment must have a built-in operational monitoring feature permitting the boatmaster to check variations in operating parameters and to set the instrument correctly when radar targets are unavailable.

10B-4.5 The image on the radar indicator must be clearly visible irrespective of the lighting conditions in the wheelhouse. The illumination of the controls and the indicator should not be so intense as to dazzle the boatmaster when he is operating the vessel.

10B-4.6 The radar antenna must be installed so as to ensure that there is the best possible coverage on the indicator screen along the vessel's course, with no dead sectors within 5° to port or starboard, and that the coverage of the horizon is, if possible, unobstructed by superstructure, piping or other structures.

10B-4.7 The antenna must be installed sufficiently high up to ensure that the high-frequency radiation flux density on open decks where there may be people does not exceed the permitted level.

^{11/} Note by the secretariat: It is suggested to translate the term "bouteurs actifs" as "active bow rudders" in English and "aktivnye nosovye ruli" in Russian.

^{12/} Note by the secretariat: The term "vessel's steering station" should be brought in line with the one to be used in 7-3.3 above and elsewhere in this chapter.

10B-4.8 Onboard radar equipment must be electrically operated from the main and emergency power supplies.

10B-4.9 The rate-of-turn indicator must be located ahead of the helmsman and within his field of vision, and as close as possible to the screen of the radar equipment.

10B-4.10 Where rate-of-turn regulators are used, it shall be possible to release the rate-of-turn control in any position without any change occurring in the selected rate. The sector through which the control rotates shall be large enough to ensure that it can be positioned with sufficient accuracy. The neutral position shall be perceptibly distinguishable from the other positions. Illumination of the scale shall be continuously adjustable.

10B-4.11 Departures from or additions to the requirements listed above shall be permitted on condition that all departures and additions are validated by the establishment of better working conditions for boatmasters or the improvement of the operating and technical specifications of radar equipment.

10B-5 ALARM SYSTEM

10B-5.1 The helmsman must have within reach an on/off switch controlling the alarm signal; switches which automatically return to the off position when released are not acceptable.

10B-5.2 There shall be a general alarm system as well as an independent alarm system enabling to reach open decks; accommodation spaces; engine rooms; pump rooms, where appropriate, and other service premises.

10B-5.3 The sound pressure level for the alarm signal shall be at least 75 dB(A) within the accommodation area. In the engine rooms and pump rooms the alarm signal shall take the form of a flashing light that is visible on all sides and clearly perceptible at all points.

CHAPTER 11

SPECIAL WHEELHOUSE ARRANGEMENTS FOR RADAR STEERING BY ONE PERSON

11-1 GENERAL PROVISION

A wheelhouse shall be deemed to be specially arranged for radar steering by one person if it meets the requirements of this chapter.

11-2 GENERAL REQUIREMENTS RELATING TO DESIGN

11-2.1 The wheelhouse shall be designed in such a way that the helmsman ¹³ shall be able to accomplish his task while seated.

11-2.2 All appliances, instruments and controls shall be so arranged that the helmsman can use them conveniently during the voyage without leaving his seat and without losing sight of the radar screen.

11-2.3 The radar display shall be placed in the wheelhouse forward of the helmsman's position in such a way that the helmsman can observe the image on the screen with no significant change in his line of vision. The radar image shall continue to be perfectly visible, without a mask or screen, whatever the lighting conditions applying outside the wheelhouse. The rate-of-turn indicator shall be installed directly above or below the radar screen or be incorporated into this.

11-3 SIGNALLING EQUIPMENT

11-3.1 Signal lights shall be controlled from a light-control switchboard on which the tell-tale lamps shall be arranged in position corresponding to the actual positions of the signal lights. Failure of a signal light shall cause the corresponding tell-tale lamp to go out or to be signalled in another manner by the corresponding warning light.

11-3.2 It shall be easy to operate the acoustic warning signals while performing steering operations.

11-4 INSTALLATIONS FOR MANOEUVRING THE VESSEL AND CONTROLLING THE PROPELLING MACHINERY

11-4.1 The vessel's steering gear shall be controlled by one lever, which can be easily manipulated manually. Every movement of the steering device shall be accompanied by an exact indication of the position of the rudders. The neutral position shall be perceptibly indicated. The rudders shall remain in position in the absence of further actuations of the steering device.

^{13/} Note by the secretariat: The Working Party on the Standardization of Technical and Safety Requirements in Inland Navigation, at its twenty-first session, asked the Group of Volunteers to check if the term "helmsman" in this paragraph and elsewhere in this chapter should not be replaced by "boatmaster" ("conducteur" in French and "sudovoditel" in Russian) (TRANS/SC.3/WP.3/42, para. 9, chapter 11 (ii)).

11-4.2 If the vessel is also fitted with reversing rudders or bow rudders, they shall be controlled by separate devices meeting the above requirements. This requirement shall also apply to convoys where the steering gear of vessels other than the vessels propelling the convoy is used.

11-4.3 The number of revolutions of the main engine or the propellers and the direction of rotation of the propellers shall be indicated.

11-4.4 A device for emergency stopping of the main machinery shall be provided and shall function independently of the remote control system.

11-5 INSTALLATIONS FOR ANCHOR MANOEUVRES

11-5.1 The helmsman shall be able, without leaving his seat, to drop anchors which are necessary for an emergency stop of his vessel.

11-6 COMMUNICATION EQUIPMENT

11-6.1 Vessels shall be fitted with a radiotelephone installation for ship-to-ship and ship-to-shore communication. Reception shall be by loudspeaker and transmission by fixed microphone. Reception/transmission shall be selected by a push-button.

11-6.2 The connection to the public communication system if available shall be independent of the installation referred to in paragraph 11-6.1.

11-6.3 There shall be a voice intercommunication network on board. It shall enable the helmsman to communicate at least with the bow of the vessel or the head of the convoy, the skipper's cabin, the crew accommodation and the stern of the craft or convoy if no other means of direct communication from the wheelhouse is possible. The voice intercommunication network shall be so installed that the helmsman can easily use it while carrying out the steering operations. At all sound-link locations, reception shall be by loudspeaker and transmission by fixed microphone. The link with the bow and stern of the craft or head and stern of the convoy may be by radio-telephone.

11-7 CERTIFICATES

11-7.1 Where a vessel complies with the requirements of this chapter in respect of wheelhouses that have been designed for radar navigation by one person, the following statement shall be entered in the certificate:

“The vessel has special wheelhouse arrangements for steering on radar by one person”.

CHAPTER 11 BIS

MOVABLE WHEELHOUSES

11 bis-1 GENERAL REQUIREMENTS

11 bis-1.1 Movable wheelhouses should be fitted with an emergency lowering system. All lowering operations should automatically trigger an audible warning signal. That requirement shall not apply if the risk of corporal injury which may result from lowering is prevented by appropriate design features.

It must be possible to leave the wheelhouse safely whatever its position.

11 bis-1.2 A vertically movable wheelhouse and its gear shall be designed in such a way as not to adversely affect the safety of persons on board.

11 bis-1.3 Hoisting and lowering shall not interfere with operations performed from the wheelhouse.

11 BIS-2 REQUIREMENTS RELATING TO CONSTRUCTION

11 bis-2.1 The hoisting mechanism shall be designed to hoist at least 1.5 times the weight of the wheelhouse fully equipped and fully manned.

11 bis-2.2 The mechanism for hoisting the wheelhouse shall function reliably and without jamming under all possible conditions of asymmetrical load as well as at all angles of ship's list and trim which could occur during its normal operation.

11 bis-2.3 The wheelhouse shall be earthed.

11 bis-2.4 The feed cables for systems inside the wheelhouse shall be laid and fastened in such a way as to exclude the possibility of mechanical damage to them.

11 bis-2.5 The device for fastening the cables may also be used for laying hoses or pipes leading into the wheelhouse. The distance between such hoses or pipes and the cables shall be not less than 100 mm.

11 bis-2.6 Optical signalling of the following positions shall be provided:

- (i) Electric drive switchboard live;
- (ii) Wheelhouse in lower terminal position;
- (iii) Wheelhouse in upper terminal position.

11 bis-3 REQUIREMENTS RELATING TO THE HOISTING GEAR DRIVE

11 bis-3.1 The gear for hoisting and lowering the wheelhouse shall have a power drive capable of functioning under all conditions of the ship's operation.

11 bis-3.2 Emergency lowering of the wheelhouse shall be effected under its own weight and shall be smooth and controllable.

11 bis-3.3 The hoisting mechanism shall enable the wheelhouse to stop and remain in any position.

On board ships intended for zones 1 and 2 the [Competent Authorities] ^{14/} may require that it shall be possible to fix the wheelhouse in different positions. A possibility for immediate release of the fixing arrangements should be ensured under all operational conditions inclusive of a total power failure.

11 bis-3.4 Automatic cutting out of the hoisting mechanism in the terminal positions shall be provided.

11 bis-3.5 Lowering of the wheelhouse shall be effected by one person under all conditions. Emergency lowering control shall be possible from both inside the wheelhouse and a control station outside. The speed of emergency lowering of the wheelhouse shall be not less than the speed of lowering effected by means of the main drive.

11 bis-3.6 The use of a self-braking hoisting mechanism shall not be permitted.

^{14/} Note by the secretariat: The Group of Volunteers is expected to consider the possible revision of the definition of the terms "Administration" used in the draft amended chapters, together with the terms "Competent Authorities" or "Administration of the river basin", "Recognized classification society", etc. with a view to reducing the number of terms referring to the functions and responsibilities of the State Administration and other bodies to which the State may wish to delegate those functions and responsibilities.

CHAPTER 12

FIRE PROTECTION

12-1 STRUCTURAL REQUIREMENTS

12-1.1. The hull, superstructures, structural bulkheads, decks and deckhouses shall be made of steel. The Administration or a recognized Classification Society may allow the use of other materials with due regard to the risk of fire.

In addition to the requirement set out in the first sentence of 12-1.1 above on vessels with a length of 85 m or more and intended for navigation in zone 1, in accommodation spaces, the corridor bulkheads shall be made of steel or other materials approved by the Administration or recognized Classification Society with due regard to the risk of fire.

12-1.2 Crew elevator trunks within accommodation and interior stairways below the open deck shall be made of steel or equivalent material.

12-1.3 The bulkheads of galleys, paint stores, lamprooms, boatswain's stores (when adjacent to accommodation spaces) and emergency generator rooms, if any, shall be made of steel or equivalent material.

12-1.4 Deck, bulkheads and ceiling coverings within accommodation spaces, especially on decks forming the upper part of machinery space and store rooms and escape routes shall be made of fire-resistant materials. The furniture in the above-mentioned accommodation spaces shall be made of a material which will not easily catch fire. In the case of fire or heating the materials shall not release toxic or explosive gases in dangerous concentrations.

12-1.5 Bulkheads, ceilings and doors of machinery spaces, boiler rooms and bunkers shall be made of steel or equally fire-resistant material.

Stairways and ladders leading to machinery spaces, boiler rooms and bunkers shall be fixed permanently and made of steel or equivalent material.

12-1.6 Paints, varnishes and similar products having a nitro-cellulose or other highly inflammable base shall not be used in machinery spaces.

12-1.7 Tanks and their pipelines as well as other accessories shall be laid out and arranged with due regard to the risk of fire and in such a way that no fuel or gas can escape accidentally into the vessel. Tank valves intended for fuel sampling or water drainage shall close automatically. Materials with a low resistance to heat shall not be used for overboard scuppers, sanitary discharges or other outlets which are close to the water line, or in places where failure of the material in the event of fire might cause flooding.

12-1.8 At tank outlets the pipelines for the distribution of liquid fuels shall be fitted with a shutoff device that can be operated from the deck.

12-1.9. Electric radiators shall be so designed and fixed in position as to reduce fire risks to a minimum.

12-1.10. Forced ventilation of machinery spaces shall be capable of being stopped from an easily accessible position outside the machinery spaces.

12-1.11. Automatic devices for detecting and signalling about smoke or heat, which indicate fire on board, shall satisfy the requirements of the Administration or recognized Classification Society.

12-2 MEANS OF ESCAPE

12-2.1. In all crew spaces and spaces in which crew members are normally employed, stairways and ladders shall be so installed as to provide a ready means of escape to an open deck.

12-2.2. Living and sleeping quarters shall have at least two exits as far apart from each other as possible which serve as escape routes. One of them may be designed as an emergency exit. This does not apply to areas with an exit giving directly onto the deck or into a corridor which serves as an escape route, provided the corridor has two exits at a distance from each other and giving onto port and starboard. Emergency exits, which may include skylights and windows, shall have a clear opening of at least 0.36 m² with a smallest side of at least 0.50 m and permit rapid evacuation in an emergency.

12-2.3. Engine and boiler rooms shall have two exits of which one may be an emergency exit.

The second exit may be dispensed with if:

- (a) the total floor area (average length x average width) of the engine or boiler room does not exceed 35 m² and
- (b) the distance between each point where service or maintenance operations are to be carried out and the exit, or foot of the stairway near the exit providing access to the outside, is not longer than 5 m and
- (c) a fire extinguisher is placed at the maintenance station that is furthest removed from the exit door and also, by way of a derogation from Article 12-3.1 (e) below, where the installed power of the engines does not exceed 100 kW.

12-3 FIRE-FIGHTING APPLIANCES

12-3.1. There shall be at least:

- (a) in the wheelhouse: 1 portable fire extinguisher;
- (b) close to each means of access from the deck to the accommodation: 1 portable fire extinguisher;
- (c) close to each means of access to service premises that are not accessible from the

- | | |
|---|-------------------------------|
| accommodation, and which contain heating, cooking or refrigerating equipment using solid or liquid fuels | 1 portable fire extinguisher; |
| (d) at each entrance to the engine room and boiler rooms: | 1 portable fire extinguisher; |
| (e) at an appropriate point in the engine rooms that is beneath the deck, where the total power output is more than 100 kW: | 1 portable fire extinguisher. |

12-3.2. The extinguishers shall be suitable for their purpose and shall meet the requirements of the Administration or recognized Classification Society. They shall be inspected and checked at least once every two years. A certificate to that effect, signed by the firm or person that carried out the inspection, shall be kept on board.

12-3.3. The extinguishing substance may neither be halon nor contain a product which is likely to release toxic gases, such as carbon tetrachloride during use. Portable fire extinguishers using CO₂ may only be used to fight fires at specific locations such as electrical installations, kitchens; the quantity of CO₂ shall not constitute a health hazard.

12-3.4. Extinguishers sensitive to frost or heat shall be installed or protected in such a manner that they are always ready for use.

12-3.5. If the fire-fighting appliances are so installed as to be concealed from view, the plates or doors concealing them shall bear a red symbol not less than 100 mm high.

12-3.6. Fixed fire-extinguishing installations shall meet the requirements of the Administration or of a recognized Classification Society. The use of halon is not authorized. The equipment shall be checked at least every two years by an approved expert. The dated inspection certificates, signed by the inspector involved, shall be kept on board.

12-3.7. In addition to the above provisions of this chapter, all vessels intended for navigation in zone 1 shall be provided with fire pumps, pressure piping for fire-extinguishing water, and fire hydrants and hoses. The equipment shall meet the requirements of the Administration or recognized Classification Society.

12-3.8. In addition to the above provisions of this chapter, vessels with a length of 110 m or more and intended for navigating in zone 1 shall have a fixed fire-extinguishing installation installed in:

- (a) rooms in which main or auxiliary oil-fired boilers are installed and rooms containing fuel pumps or settling tanks;
- (b) rooms containing internal combustion engines constituting the main means of propulsion or used as auxiliary engines with the installed total capacity of not less than 750 kW.

CHAPTER 13

LIFE-SAVING APPLIANCES

13-1 DEFINITIONS AND EXPLANATIONS

13-1.1 Collective life-saving appliances: lifeboats, liferafts, ship's boats and life-saving buoyancy aids intended for rescue of passengers and the ship's crew.

13-1.2 Lifeboat: a boat intended for rescue of people in distress complying with the requirements of the basin Administration, [a recognized Classification Society] or IMO Code.

13-1.3 Liferaft: a raft intended for rescue of people in distress, keeping them out of the water complying with the requirements of the basin Administration, [a recognised Classification Society] or IMO Code.

13-1.4 Ship's boat: a boat used for multipurpose application including transportation of people or cargoes as well as in rescue purposes complying with the requirements of the basin Administration or the European Standard.

13-1.5 Life-saving buoyancy aids: means intended for supporting several persons overboard on the water surface.

13-1.6 Individual life-saving appliances: means intended for supporting a person overboard on the water surface. They include lifejackets and lifebuoys.

13-2 COLLECTIVE LIFE-SAVING APPLIANCES

13-2.1 General requirements

13-2.1.1 Collective life-saving appliances shall:

- (i) carry an indication of the use and of the number of persons for which they are approved;
- (ii) have and maintain a stable trim if grabbed by the indicated number of persons;
- (iii) be fitted with a line securely fastened round the outside perimeter enabling them to be grabbed by persons being in water;
- (iv) be made of a suitable material and be resistant to oil and oil products, and to temperatures of up to 50 °C;
- (v) have a fluorescent orange colour or have permanently fixed fluorescent surfaces measuring at least 100 cm²;
- (vi) be rapidly and safely launchable from their place of storage by a single person;
- (vii) be checked in accordance with manufacturer's instructions.

13-2.1.2 Inflatable life-saving appliances shall in addition to 13-2.1.1 :

- (i) comprise at least two separate air compartments;
- (ii) inflate automatically or by manual command when launched;
- (iii) have and maintain a stable trim whatever load it is supporting, even with only half of the air compartments inflated;
- (iv) be checked in accordance with the manufacturer's instructions.

13-2.2 Lifeboats

13-2.2.1 All lifeboats shall be well designed and of such shape and proportions that they have ample stability and sufficient freeboard when carrying their full load of persons and equipment.

13-2.2.2 All lifeboats shall be strong enough to be lowered into the water with complete safety when carrying their full load of persons and equipment. They shall be of such strength that they will not suffer permanent deformation if subjected to an overload of 25%.

13-2.2.3 Every lifeboat shall meet the following requirements:

- (i) it shall be equipped with seats sufficient for at least three persons;
- (ii) the number of persons whom the lifeboat is permitted to carry shall be determined according to its cubic capacity as calculated by the recognized methods, on the basis of not less than 0.225 m³ per person. The seating capacity of the lifeboat shall be determined by tests to find out how many adults wearing lifejackets can be accommodated without interfering with the rowing and steering of the lifeboat;
- (iii) the lifeboat stability shall be adequate for the maximum number of persons it may carry; its stability shall be deemed to be adequate if, with half the maximum permissible number of persons seated on one side of the lifeboat, there remains a freeboard of not less than 100 mm;
- (iv) there shall be a seat width of not less than 0.45 m per person;
- (v) the lifeboat shall remain sufficiently buoyant and sufficiently stable when carrying its full load of persons and equipment and filled with water.

13-2.2.4 The lifeboat equipment shall meet the requirements of the basin Administration [or a recognized Classification Society].

13-2.3 Liferafts

13-2.3.1 Every liferaft shall be fitted with devices for mooring and towing.

13-2.3.2 Every liferaft shall be so constructed as to comprise units containing a volume of air of at least 0.096 m³ (or equivalent buoyancy devices in the case of rigid liferafts), and a deck area of at least 0.372 m², for every person it is permitted to carry.

13-2.3.3 The liferaft shall be so constructed that if it is dropped into the water from a height of 10 metres, neither the liferaft nor its equipment will be damaged.

13-2.3.4 Liferaft equipment shall comply with the requirements of the basin Administration [or a recognized Classification Society].

13-2.3.5 Inflatable liferafts are in addition to paras. 13-2.3.1 – 13-2.3.4 to meet the following requirements:

- (i) every inflatable liferaft shall be so designed that, when fully inflated and floating, it is stable in the water;
- (ii) the liferaft shall be capable of being easily righted by one person in the water if it inflates upside down;
- (iii) the liferaft shall be fitted with appropriate means of enabling persons in the water to climb on board;
- (iv) the liferaft shall be packed in a valise or container capable of withstanding hard wear and use; the liferaft in its valise or container shall float in such a way as to permit the immediate operation of the inflation system.

13-2.3.6 Rigid liferafts shall in addition to paras. 13-2.3.1 – 13-2.3.4 meet the following requirements:

- (i) rigid liferaft shall be so constructed as to retain its shape in all weather conditions, on deck and in the water;
- (ii) the deck area of the liferaft shall be situated within that part of the liferaft which affords protection to its occupants. The nature of the deck shall be such as to prevent so far as practicable the ingress of water and it shall effectively hold the occupants out of the water;
- (iii) the equipment of the liferaft shall be so stowed as to be readily accessible whichever way up the liferaft is floating.

13-2.4 Ship's boats

13-2.4.1 Ship's boats may be used as a collective life-saving appliance if complying with the requirements of 13-2.1.

13-2.4.2 The ship's boats shall meet the following requirements:

- (i) they shall be easy to steer and manoeuvre, they shall maintain their course and not drift significantly under the effect of the wind, the current or the waves;
- (ii) they shall have seats for at least three persons;
- (iii) they shall be sufficiently resistant;

- (iv) their volume shall be at least 1.5 m³, or the product of $L_b \times B_b \times H_b$ shall represent at least 2.7 m³;
- (v) their freeboard shall be at least 25 cm with three persons of approximately 75 kg each on board;
- (vi) they shall be adequately stable. This shall be considered adequate if there is a residual freeboard of at least 10 cm when two persons of roughly 75 kg each are on one side as close as possible to the gunwale;
- (vii) their buoyancy in N with no passengers on board, but completely filled with water shall be at least equal to $300 \times L_b \times B_b \times H_b$;
- (viii) the following gear shall be on board:
 - one set of oars;
 - one mooring rope;
 - one bailer.

13-2.4.3 It shall be possible for one person to launch such ship's boats safely. If a power-driven unit is used for launching it should be ensured that a failure of the power supply will not jeopardize rapid and safe launching.

13-2.4.4 Inflatable ship's boats shall be permitted provided the conditions set out in paragraphs 13-2.4.2 and 13-2.4.3 are met, that they are permanently operational and that they have several compartments.

13-2.4.5 If a ship's boat is used on a passenger vessel as a lifeboat it shall at least meet the conditions set out in paragraph 13-2.4.2. However,

- (i) seat width shall be at least 0.45 m per person, while the maximum permissible number of persons shall not exceed the product of $3 \times L_b \times B_b \times H_b$;
- (ii) their stability shall be considered adequate if there is a freeboard of at least 10 cm when half of the maximum number of passengers permitted are positioned on one side of the ship's boat.

Note: In paras. 13-2.4.2 and 13-2.4.5:

- L_b is the ship's boat length in metres;
- B_b is the ship's boat width in metres;
- H_b is the ship's boat depth in metres.

13-2.5 Life-saving buoyancy aids

13-2.5.1 Life-saving buoyancy aids shall provide a buoyancy of at least 100 N per person in fresh water.

13-3 INDIVIDUAL LIFE-SAVING APPLIANCES

13-3.1 General requirements

13-3.1.1 Individual life-saving appliances shall meet the following requirements:

- (i) to provide a buoyancy of at least 100 N in fresh water;
- (ii) to be made of a suitable material and be resistant to oil and oil products, and to temperatures of up to 50 °C;
- (iii) have a fluorescent orange colour or have permanently fixed fluorescent surfaces measuring at least 100 cm²;
- (iv) to be capable of supporting an iron load of 7.5 kg in fresh water for 24 hours.

13.3.2 Lifejackets

13-3.2.1 A lifejacket shall satisfy the following requirements:

- (i) it shall be capable of keeping the head of an exhausted or unconscious person above water;
- (ii) it shall be so designed as to eliminate so far as possible all risk of its being put on incorrectly; however, it shall be capable of being worn inside out;
- (iii) it shall be capable of turning the wearer's body, on entering the water, to a safe floating position slightly inclined backwards from the vertical;
- (iv) it shall be easy and quick to put on, and shall fasten securely to the body;

13-3.2.2 Inflatable life jackets shall inflate automatically and manually and may also be inflated by mouth. They shall be checked in accordance with the manufacturer's instructions.

13-3.2.3 Inflatable lifejackets shall meet the requirements of the basin Administration.

13-3.3 Lifebuoys

13-3.3.1 Lifebuoys shall meet the following requirements:

- (i) have a mass of not less than 2.5 kg;
- (ii) have an internal diameter of 0.45 m \pm 10%;
- (iii) be encircled with rope which can be grasped.

13-3.3.2 At least one lifebuoy on each side of the vessel shall be fitted with a reliably secured buoyant lifeline which is not less than 25 m long.

13-4 STOWAGE AND HANDLING OF LIFE-SAVING APPLIANCES

13-4.1 Life-saving appliances shall be stored on board in such a way that in case of need it can be easily and safely reached. Concealed storage places shall be clearly signed.

13-4.2 The lifeboat launching devices - davits, falls, blocks and other gear - shall be of such strength that the lifeboats can be safely lowered on either side in unfavourable conditions of list or trim.

13-4.3 All collective life-saving appliances shall be so stowed that they can be launched as quickly as possible.

13-4.4 The lifebuoys shall be ready for use and located on deck at suitable places, but shall not be fastened into their holders. At least one lifebuoy shall be placed in the immediate vicinity of the wheelhouse.

13-4.5 Where necessary, equipment should be provided to pull launchable collective life-saving appliances towards the side of the vessel and restrain them in that position to facilitate safe embarkation.

13-5 NUMBER AND CAPACITY OF LIFE-SAVING APPLIANCES

13-5.1 General

13-5.1.1 In general, all vessels shall be provided with life-saving appliances appropriate to the navigation zone, as specified below.

13-5.2 Vessels navigating in zone 1

13-5.2.1 Vessels navigating in zone 1 shall have:

- (i) - either on each side of the vessel, one or more lifeboats of sufficient aggregate capacity to accommodate all persons on board;
 - or one or more lifeboats capable of being launched on either side of the vessel and of sufficient aggregate capacity to accommodate all persons on board;
 - or ship's boat and, on each side of the vessel, one or more liferafts of sufficient aggregate capacity to accommodate all persons on board;
- (ii) one or more liferafts of sufficient aggregate capacity to accommodate half the total number of persons on board;
- (iii) a sufficient number of lifejackets for all persons on board;
- (iv) at least four lifebuoys, of which at least two shall be equipped with a source of light if the vessel travels at night.

13-5.2.2 Vessels navigating in zone 1 need not be equipped with liferafts provided that they are equipped with lifeboats in accordance with paragraph 13-5.2.1, subparagraph (i), first item above.

13-5.3 Vessels navigating in zones 2 and 3

13-5.3.1 Vessels navigating in zones 2 and 3 shall have:

- (i) collective life-saving appliances conforming in number and capacity to the requirements of the basin Administration [or a recognized Classification Society];
- (ii) a sufficient number of lifejackets for all persons on board;
- (iii) at least three lifebuoys for smaller vessels, although two lifebuoys may be allowed by the basin Administration. At least one of these buoys shall be equipped with a source of light if the vessel travels at night.

These provisions shall not apply to unmanned vessels such as pushed barges.

13-5.4 Passenger vessels

13-5.4.1 Passenger vessels must be supplied additionally with lifejackets for children in quantity equal to 10 per cent of the total number of passengers.

13-6 FITTING WITH SHIP'S BOATS

13-6.1 The following vessels shall carry a ship's boat:

- (i) self-propelled vessels and manned barges of more than 150 tonne dwt;
- (ii) tugs and pushers of more than 150 m³ displacement;
- (iii) floating equipment (floating cranes, dredgers etc.);
- (iv) passenger vessels [authorized to carry more than 250 passengers or fitted with more than 50 beds] ^{15/}.

^{15/} Note by the secretariat: Given the latest RVBR developments the Group of Volunteers proposed to delete the text in brackets. The Working Party SC.3 may wish to decide as appropriate.

CHAPTER 14

PUSHERS, ^{16/} PUSHED BARGES AND PUSHED AND TOWED CONVOYS

14-1 PUSHERS

14-1.1 Pushers shall have at the bow a suitable pushing device so designed and equipped that, from the start of the coupling manoeuvres:

- (i) the pusher can take up a fixed position in relation to the pushed barges;
- (ii) the crew can perform easily and safely the manoeuvres required for coupling the pusher to the barges.

14-1.2 Pushers shall be equipped with at least two special winches or equivalent coupling devices, which shall satisfy the following requirements:

- (i) all components of the coupling device shall be capable of withstanding the maximum operational stresses imposed under the severest conditions to be encountered in the navigation zone for which the vessel is intended;
- (ii) the coupling devices shall ensure the rigid coupling with the pushed vessel or vessels; where convoys consist of a pusher vessel and a single pushed vessel, the coupling devices may permit controlled articulation. The control systems required for this purpose shall easily absorb the forces to be transmitted and shall be capable of being controlled easily and safely. Sections 10A-3 to 10A-5 shall apply by analogy to such control systems;
- (iii) it shall be possible to couple the pusher to both loaded and empty barges;
- (iv) the coupling device shall be so positioned on deck as not to interfere with the operation of other deck mechanisms, and the parts of the coupling device shall not project beyond the vessel's breadth over-all.

14-1.3 Vessels intended to propel side-by-side formations shall be equipped with bollards or equivalent devices the number and arrangement of which permit the formation to be securely linked.

14-2 PUSHED BARGES

14-2.1 Chapter 5, section 7-3, chapters 10A, 10B, X and 17 shall not apply to pushed barges with no steering system, accommodation, engine room or boilers.

14-2.2 Ships' lighters having a length L of 40 m or less shall in addition meet the following construction requirements:

- (i) The watertight transverse bulkheads referred to in paragraph 4-2.1 shall not be required if the forward side is capable of bearing a load at least 2.5 times that

^{16/} In the present chapter the term «pusher» is applied also to self-propelled barges built to propel a pushed convoy or a vessel.

stipulated for the collision bulkhead of an inland waterway vessel with the same draught, built to the requirements of a recognized classification society;

- (ii) Notwithstanding paragraph 5-6.1, double-bottomed compartments to which access is difficult only have to be drainable if their volume exceeds 5% of the water displacement of the ships' lighter at the maximum authorized loaded draught.

14-2.3 Vessels intended for use in convoys shall be equipped with coupling devices, bollards or equivalent devices, the number and arrangement of which permit a secure link with other vessels or vessels of the convoy. ^{17/}

14-3 TOWING VESSELS

14-3.1 Vessels to be used for towing operations shall meet the following requirements:

- (i) Towing equipment shall be arranged in such a way that its use does not impair the safety of the vessel, crew or the cargo.
- (ii) Vessels to be used for auxiliary or main towing shall be equipped with towing devices: a towing winch or a tow hook which shall be capable of slipping, for the towing winch, or safe release, for the tow hook, from the steering position ^{18/}.
- (iii) The towing devices shall be installed forward of the propeller plane. That requirement shall not apply to vessels steered by cycloidal propellers or similar propulsion units.
- (iv) Notwithstanding the requirements of (ii) above, in the case of vessels to be used solely for auxiliary towing, other towing devices such as a bollard, to be installed forward of the propeller plane, may be used.

14-3.2 The Basin Administration may limit the length of the vessel to be used for downstream towing.

14-4 TESTS ON CONVOYS OF VESSELS

14-4.1 In order to issue the certificate of fitness of a pusher or a self-propelled barge capable of propelling a rigid convoy, and to enter relevant particulars in the certificate, the competent authority shall decide whether and which convoys are to be presented to it for inspection and shall carry out the navigation tests referred to in section X-2 with the convoy in the requested formation(s), which it considers to be least favourable. The convoy must meet the requirements set out in sections X-2 to X-10.

The competent authority shall check that the rigid coupling of all the vessels in the convoy is assured during the manoeuvres prescribed in chapter X.

^{17/} The Administration or the competent authority for the waterway may prescribe a minimum speed for particular sectors of the waterway.

^{18/} Note by the secretariat: See footnote 4 to paragraph 7-3.3 above.

14-4.2 If, in the course of the tests referred to in section 14-4.1 above, special equipment installed on vessels that are being pushed or led side-by-side is used, such as propelling or manoeuvring installations or articulated couplings, in order to meet the requirements of sections X-2 to X-10, the following shall be mentioned in the certificate of the vessels propelling the convoy: the formation, its position, the name and official number of the vessels making part of the convoy and fitted with the special equipment used.

14-5 ENTRIES ON THE CERTIFICATE

14-5.1 If a vessel is intended to push a convoy, or to be pushed in a convoy, the certificate shall mention its compliance with the applicable requirements of sections 14-1 to 14-4 above.

14-5.2 The following particulars shall be entered in the certificate of the vessel intended to ensure propulsion of another vessel or a convoy:

- (i) the convoys and formations permitted;
 - (ii) types of coupling;
 - (iii) maximum coupling forces transmitted and,
 - (iv) where appropriate, minimum tensile strength of the coupling cables for the longitudinal connection and the number of turns of the cable on the bollard.
-