

AGREEMENT

**CONCERNING THE ADOPTION OF UNIFORM CONDITIONS OF APPROVAL
AND RECIPROCAL RECOGNITION OF APPROVAL
FOR MOTOR VEHICLE EQUIPMENT AND PARTS**

done at Geneva on 20 March 1958

Addendum 85: Regulation No. 86

Date of entry into force: 1 August 1990

**UNIFORM PROVISIONS CONCERNING THE APPROVAL
OF AGRICULTURAL OR FORESTRY TRACTORS WITH REGARD TO THE INSTALLATION
OF LIGHTING AND LIGHT-SIGNALLING DEVICES**



UNITED NATIONS



Regulation No. 86

UNIFORM PROVISIONS CONCERNING THE APPROVAL OF AGRICULTURAL OR
FORESTRY TRACTORS WITH REGARD TO THE INSTALLATION OF LIGHTING
AND LIGHT-SIGNALLING DEVICES

CONTENTS

	<u>Page</u>
REGULATION	
1. Scope	4
2. Definitions	4
3. Application for approval	10
4. Approval	10
5. General specifications	11
6. Individual specifications	17
7. Modification and extension of approval of the vehicle type or of the installation of its lighting and light-signalling devices . . .	41
8. Conformity of production	42
9. Penalties for non-conformity of production	42
10. Production definitely discontinued	42
11. Names and addresses of technical services responsible for conducting approval tests, and of administrative departments . . .	43
ANNEXES	
<u>Annex 1</u> : Communication concerning the approval or extension or refusal or withdrawal of approval or production definitely discontinued of a type of agricultural or forestry tractor with regard to the installation of lighting and light-signalling devices pursuant to Regulation No. 86	45
<u>Annex 2</u> : Examples of arrangements of approval marks	48
<u>Annex 3</u> : Definitions of the terms of paragraphs 2.7 - 2.11	49
<u>Annex 4</u> : Visibility of lamps	50
<u>Annex 5</u> : Direction-indicator lamps - Geometric visibility	51

Regulation No. 86

UNIFORM PROVISIONS CONCERNING THE APPROVAL OF AGRICULTURAL OR
FORESTRY TRACTORS WITH REGARD TO THE INSTALLATION OF LIGHTING
AND LIGHT-SIGNALLING DEVICES

1. SCOPE

- 1.1. This Regulation applies to the approval of agricultural or forestry tractors with regard to the installation of lighting and light-signalling devices.
- 1.2. This Regulation applies only to:
- 1.2.1. agricultural or forestry tractors, as defined in paragraph 2.1 below, which are fitted with pneumatic tyres and which have at least two axles and a maximum design speed of between 6 and 30 km/h.

2. DEFINITIONS

For the purposes of this Regulation,

- 2.1. "Agricultural or forestry tractor" means any motor vehicle, fitted with wheels, having at least two axles, the main function of which lies in its tractive power and which is specially designed to tow, push, carry or power certain tools, machinery or trailers intended for agricultural or forestry use. It may be equipped to carry a load and passengers.
- 2.2. "Tractor type with regard to the installation of lighting and light-signalling devices" means tractors which do not differ in such essential respects as:
- 2.2.1. the dimensions and exterior shape of the tractor;
- 2.2.2. the number and positioning of the devices;
- 2.2.3. The following are likewise considered not to be tractors of a different type:

tractors which differ within the meaning of paragraphs 2.2.1. and 2.2.2. above, but not in such a way as to entail a change in the type, number, positioning and geometric visibility of the lamps prescribed for the tractor type in question;

tractors on which optional lamps are fitted or are absent;

tractors which are fitted with lamps, the position of which varies according to the direction of traffic in the country of registration.

- 2.3. "Transverse plane" means a vertical plane perpendicular to the median longitudinal plane of the tractor;
- 2.4. "Unladen tractor" means the tractor in running order, i.e. excluding optional accessories but including coolant, oils, fuel, tools and driver;
- 2.5. "Laden tractor" means the tractor loaded to its technically permissible maximum mass, as stated by the manufacturer, who shall also fix the distribution of this weight between the axles;
- 2.6. "Lamp" means a device designed to illuminate the road (headlamp) or to emit a light signal. Rear registration-plate lamps and retro reflectors shall likewise be regarded as lamps;
- 2.6.1. "Equivalent lamps" means lamps having the same function and approved under Regulation No. 37 or in conformity with the same requirements; such lamps may have different characteristics from those of the lamps with which the vehicle is equipped at the time of approval on condition that they satisfy the requirements of this Regulation;
- 2.6.2. "Independent lamps" means lamps having separate lenses, separate light sources, and separate lamp bodies;
- 2.6.3. "Grouped lamps" means devices having separate lenses and separate light sources, but a common lamp body;
- 2.6.4. "Combined lamps" means devices having separate lenses but a common light source and a common lamp body;
- 2.6.5. "Reciprocally incorporated lamps" means devices having separate light sources (or a single light source operating under different conditions), totally or partially common lenses and a common lamp body;
- 2.6.6. "Concealable illuminating lamp" means a headlamp capable of being partly or completely hidden when not in use. This result may be achieved by means of a movable cover, by displacement of the headlamp or by any other suitable means. The term "retractable" is used more particularly to describe a concealable lamp the displacement of which enables it to be inserted within the bodywork;
- 2.6.7. "Lamps of variable position" means lamps installed on the tractor which can move in relation to the tractor, without being detached;
- 2.6.8. "Driving-lamp" means the lamp used to illuminate the road over a long distance ahead of the tractor;

- 2.6.9. "Passing lamp" means the lamp used to illuminate the road ahead of the tractor without causing undue dazzle or discomfort to oncoming drivers and other road-users;
- 2.6.10. "Front fog-lamp" means the lamp used to improve the illumination of the road in case of fog, snowfall, rainstorms or dust clouds;
- 2.6.11. "Reversing lamp" means the lamp used to illuminate the road to the rear of the tractor and to warn other road-users that the tractor is reversing or about to reverse;
- 2.6.12. "Direction-indicator lamp" means the lamp used to indicate to other road-users that the driver intends to change direction to the right or to the left;
- 2.6.13. "Hazard-warning signal" means the device permitting the simultaneous operation of all of a tractor's direction indicator lamps to draw attention to the fact that the tractor temporarily constitutes a special danger to other road-users;
- 2.16.14. "Stop lamp" means the lamp used to indicate to other road-users to the rear of the tractor that the latter's driver is applying the service brake;
- 2.6.15. "Rear-registration-plate lamp" means the device used to illuminate the space intended to accommodate the rear registration plate; it may consist of several optical components;
- 2.6.16. "Front position (side) lamp" means the lamp used to indicate the presence and the width of the tractor when the latter is viewed from the front;
- 2.6.17. "Rear position (side) lamp" means the lamp used to indicate the presence and the width of the tractor when the latter is viewed from the rear;
- 2.6.18. "Rear fog-lamp" means the lamp used to make the tractor more easily visible from the rear in dense fog;
- 2.6.19. "Parking lamp" means the lamp used to draw attention to the presence of a stationary tractor, without a trailer, in a built-up area. In such circumstances it replaces the front and rear position (side) lamps;
- 2.6.20. "End-outline marker lamp" means the lamps fitted to the extreme outer edge as close as possible to the top of the tractor and intended clearly to indicate the tractor's overall width. This signal is intended, for certain tractors, to complement the tractor's front and rear position (side) lamps by drawing particular attention to its bulk;

- 2.6.21. "Work lamp" means a device for illuminating a working area or process;
- 2.6.22. "Retro reflector" means a device used to indicate the presence of a tractor by reflection of light emanating from a light source unconnected with the vehicle, the observer being situated near that source. For the purpose of this Regulation, the following are not considered as retro reflectors:
- retro-reflecting number plates;
- other plates and retro-reflecting signals which must be used to comply with a Contracting Party's specifications for use as regards certain categories of vehicles or certain methods of operation.
- 2.7. Illuminating surface of a lamp (see annex 3)
- 2.7.1. "Illuminating surface of a lighting device" (paras. 2.6.8. to 2.6.11.) means the orthogonal projection of the full aperture of the reflector in a transverse plane. If the lamp glass (or glasses) extend(s) over part only of the full aperture of the reflector, then the projection of that part only is taken into account. In the case of a passing lamp, the illuminating surface is limited on the side of the cut-off by the apparent projection of the line of the cut-off on to the lens. If the reflector and glass are adjustable, the mean adjustment should be used;
- 2.7.2. "Illuminating surface of a signalling lamp other than a retro reflector" (paras. 2.6.12. to 2.6.20.) means the orthogonal projection of the lamp in a plane perpendicular to its axis of reference and in contact with the exterior light-emitting surface of the lamp, this projection being bounded by the edges of screens situated in this plane, each allowing only 98% of the total luminous intensity of the light to persist in the direction of the axis of reference. To determine the lower, upper and lateral limits of the illuminating surface, only screens with horizontal or vertical edges shall be used;
- 2.7.3. "Illuminating surface of a reflex reflector" (2.6.22.) means the orthogonal projection of the reflecting surface of the retro reflector in a plane perpendicular to its axis of reference and bounded by planes touching the outer edges of the light projection surface of the retro reflector and parallel to this axis. To determine the lower, upper and lateral limits of the illuminating surface, only vertical and horizontal planes shall be used.
- 2.7.4. "Light-emitting surface" means that part of the exterior surface of the transparent lens that encloses the lighting or light-signalling device and allows it to emit light;

- 2.8. "Apparent surface" for a defined direction of observation, means the orthogonal projection of the light-emitting surface in a plane perpendicular to the direction of observation (see annex 3);
- 2.9. "Axis of reference" means the characteristic axis of the light signal determined by the manufacturer of the lamp for use as the direction of reference ($H = 0^\circ$, $V = 0^\circ$) for photometric measurements and when fitting the lamp on the tractor;
- 2.10. "Centre of reference" means the intersection of the axis of reference with the exterior light-emitting surface, specified by the manufacturer of the lamp;
- 2.11. "Angles of geometric visibility" means the angles which determine the field of the minimum solid angle in which the apparent surface of the lamp must be visible. That field of the solid angle is determined by the segments of the sphere of which the centre coincides with the centre of reference of the lamp and the equator is parallel with the ground. These segments are determined in relation to the axis of reference. The horizontal angles β correspond to the longitude and the vertical angles α to the latitude. There must be no obstacle on the inside of the angles of geometric visibility to the propagation of light from any part of the apparent surface of the lamp observed from infinity. If measurements are taken closer to the lamp, the direction of observation must be shifted parallel to achieve the same accuracy.

On the inside of the angles of geometric visibility no account is taken of obstacles, if they were already presented when the lamp was type-approved.

If, when the lamp is installed, any part of the apparent surface of the lamp is hidden by any further parts of the vehicle, proof shall be furnished that the part of the lamp not hidden by obstacles still conforms to the photometric values prescribed for the approval of the device as an optical unit (see explanatory figure below);

- 2.12. "Extreme outer edge" on either side of the tractor means the plane parallel with the median longitudinal plane of the tractor and coinciding with its lateral outer edge, disregarding the projection:
- 2.12.1. of tyres near their point of contact with the ground and connections for tyre-pressure gauges;
- 2.12.2. of any anti-skid devices which may be mounted on the wheels;
- 2.12.3. of rear-view mirrors;

- 2.12.4. of side direction indicator lamps, end-outline marker lamps, front and rear position (side) lamps, parking lamps and lateral reflex reflectors;
- 2.12.5. of customs seals affixed to the tractor and devices for securing and protecting such seals;
- 2.13. "Overall width" means the distance between the two vertical planes defined in paragraph 2.12 above;
- 2.14. "A single lamp" includes any combination of two or more lamps, whether identical or not, having the same function and colour, if it comprises devices, the projection of whose aggregate light-emitting surfaces in a given transverse plane occupies 60% or more of the area of the smallest rectangle circumscribing the projections of the light-emitting surfaces of the aforementioned lamps, provided that such combination is, where approval is required, approved as a single lamp.
- This possible combination does not apply to driving lamps, passing lamps, front fog lamps or lateral reflex reflectors;
- 2.15. "Two lamps" or "an even number of lamps" includes a single illuminating surface in the shape of a band, if placed symmetrically in relation to the median longitudinal plane of the tractor and extending on both sides to within not less than 400 mm of the extreme outer edge of the tractor, and being not less than 800 mm long. The illumination of such a surface shall be provided by not less than two light sources placed as close as possible to its ends. The illuminating surface may be constituted by a number of juxtaposed elements on condition that the projections of the several individual illuminating surfaces in the same transverse plane occupy not less than 60% of the area of the smallest rectangle circumscribing the projections of those individual illuminating surfaces;
- 2.16. "Distance between two lamps" which face in the same direction, means the distance between the orthogonal projections in a plane perpendicular to the direction in question of the outlines of the two illuminating surfaces as defined according to the case mentioned in paragraph 2.7;
- 2.17. "Optional lamp" means a lamp the presence of which is left to the discretion of the manufacturer;
- 2.18. "Operational tell-tale" means a tell-tale showing whether a device that has been actuated is operating correctly or not;
- 2.19. "Circuit-closed tell-tale" means a tell-tale showing that a device has been switched on but not showing whether it is operating correctly or not.

3. APPLICATION FOR APPROVAL

- 3.1. The application for approval of a vehicle type with regard to the installation of its lamps shall be submitted by the vehicle manufacturer or his duly accredited representative.
- 3.2. It shall be accompanied by the undermentioned documents in triplicate and the following particulars:
- 3.2.1. a description of the vehicle type with regard to the items mentioned in paragraphs 2.2.1 to 2.2.3 above; the vehicle type duly identified shall be specified;
- 3.2.2. a list of the devices intended by the manufacturer to form the lighting and signalling equipment; the list may include several types of device for each function, in addition, the list may include in respect of each function the additional annotation "or equivalent devices";
- 3.2.3. a diagram of the lighting and signalling installation as a whole, showing the position of the various devices on the vehicle;
- 3.2.4. a drawing or drawings of each lamp showing the illuminating surface, as defined in paragraph 2.7 above.
- 3.3. An unladen vehicle fitted with a complete set of lighting and signalling equipment and representative of the vehicle type to be approved shall be submitted to the technical service conducting approval tests.

4. APPROVAL

- 4.1. If the vehicle type submitted for approval pursuant to this Regulation meets the requirements of the Regulation in respect of all the lights specified in the list, approval of that vehicle type shall be granted.
- 4.2. An approval number shall be assigned to each type approved. Its first two digits (at present 00 for the Regulation in its original form) shall indicate the series of amendments incorporating the most recent major technical amendments to the Regulation. The same Contracting Party may not assign the same number to another vehicle type or to the same vehicle type submitted with equipment not specified in the list referred to in paragraph 3.2.2 above subject to paragraph 7 of this Regulation.
- 4.3. Notice of approval or of extension or refusal or withdrawal of approval or production definitely discontinued of a vehicle type pursuant to this Regulation shall be communicated to the parties to the Agreement which apply this Regulation by means of a form conforming to the model in annex 1 to this Regulation.

- 4.4. There shall be affixed, conspicuously and in a readily accessible place specified on the approval form, to every vehicle conforming to a vehicle type approved under this Regulation an international approval mark consisting of:
- 4.4.1. a circle surrounding the letter "E" followed by the distinguishing number of the country which has granted approval; 1/
- 4.4.2. the number of this Regulation, followed by the letter "R", a dash and the approval number to the right of the circle prescribed in paragraph 4.4.1.
- 4.5. If the vehicle conforms to a vehicle type approved under one or more other Regulations annexed to the Agreement, in the country which has granted approval under this Regulation, the symbol prescribed in paragraph 4.4.1 need not be repeated; in such a case the Regulation and approval numbers and the additional symbols of all the Regulations under which approval has been granted in the country which has granted approval under this Regulation shall be placed in vertical columns to the right of the symbol prescribed in paragraph 4.4.1.
- 4.6. The approval mark shall be placed close to or on the vehicle data plate affixed by the manufacturer.
- 4.7. The approval mark shall be clearly legible and be indelible.
- 4.8. Annex 2 to this Regulation gives an example of the arrangements of approval marks.
5. GENERAL SPECIFICATIONS
- 5.1. The lighting and light-signalling devices must be so fitted that under normal conditions of use, and notwithstanding any vibration to which they may be subjected, they retain the characteristics laid down in this Regulation and enable the tractor to comply with

1/ One for Germany, 2 for France, 3 for Italy, 4 for the Netherlands, 5 for Sweden, 6 for Belgium, 7 for Hungary, 8 for the Czech and Slovak Federal Republic, 9 for Spain, 10 for Yugoslavia, 11 for the United Kingdom, 12 for Austria, 13 for Luxembourg, 14 for Switzerland, 15 vacant, 16 for Norway, 17 for Finland, 18 for Denmark, 19 for Romania, 20 for Poland, 21 for Portugal, 22 for the Russian Federation and 23 for Greece. Subsequent numbers shall be assigned to other countries in the chronological order in which they ratify or accede to the Agreement concerning the Adoption of Uniform Conditions of Approval and Reciprocal Recognition of Approval for Motor Vehicle Equipment and Parts, and the numbers thus assigned shall be communicated by the Secretary-General of the United Nations to the Contracting Parties to the Agreement.

- 5.1. the requirements of this Regulation. In particular, it shall not
(contd) be possible for the adjustment of the lamps to be inadvertently
disturbed.
- 5.1.1. Tractors must be equipped with electrical connectors to enable
a detachable light-signalling system to be used. In particular
tractors must be fitted with the permanently connected socket
outlet specified in ISO standard 1724 (1980) (Electrical
connections for vehicles with 6 or 12 volt electrical systems
applying more specifically to private motor cars and lightweight
trailers or caravans), ISO 1185 (1975) (Electrical connections
between towing and towed vehicles having 24 volt electrical systems
used for international commercial transport purposes). In the case
of ISO standard 1185 (1975), the function of contact 2 shall be
restricted to the rear position (side) lamp and to the end-outline
marker lamp on the left-hand side.
- 5.2. The illuminating lamps described in paragraphs 2.6.8, 2.6.9 and
2.6.10 shall be so installed that correct adjustment of their
orientation can easily be carried out.
- 5.3. For all light-signalling devices, the reference axis of the lamp
when fitted to the tractor must be parallel with the bearing plane
of the tractor on the road and with the longitudinal plane of the
tractor. In each direction a tolerance of $\pm 3^\circ$ shall be allowed.
In addition, any specific instructions as regards fitting laid down
by the manufacturer must be complied with.
- 5.4. In the absence of specific instructions, the height and orientation
of the lamps shall be verified with the vehicle unladen and placed
on a flat horizontal surface.
- 5.5. In the absence of specific instructions, lamps constituting a pair
shall:
- 5.5.1. be mounted symmetrically in relation to the median longitudinal
plane;
- 5.5.2. be symmetrical to one another in relation to the median
longitudinal plane;
- 5.5.3. satisfy the same colorimetric requirements; and
- 5.5.4. have substantially identical photometric characteristics.
- 5.6. On tractors whose external shape is asymmetrical, the requirements
of paragraphs 5.5.1 and 5.5.2 shall be satisfied as far as
possible. These requirements shall be regarded as having been
met if the distance of the two lamps from the median longitudinal
plane and from the bearing plane on the ground is the same.

- 5.7. Lamps having different functions may be independent or be grouped, combined or reciprocally incorporated in one device, provided that each such lamp complies with the requirements applicable to it.
- 5.8. The maximum height above ground shall be measured from the highest point and the minimum height from the lowest point of the illuminating surface. In the case of passing lamps, the minimum height in relation to the ground is measured from the lowest edge of the reflector.
- 5.9. In the absence of specific instructions, no lamps other than direction-indicator lamps and the hazard warning signal shall be flashing lamps.
- 5.10. No red light shall be visible towards the front and no white light other than that from the reversing lamp or work lamps shall be visible towards the rear.

This requirement is considered to have been met if:

- 5.10.1. for the visibility of a red light towards the front; there is no direct visibility of a red lamp if its light-emitting surface is viewed by an observer moving within zone 1 in a transverse plane situated 25 m in front of the tractor (see annex 4, figure 1);
- 5.10.2. for the visibility of a white light towards the rear; there is no direct visibility of a white lamp if its light-emitting surface viewed by an observer moving within zone 2 in a transverse plane situated 25 m behind the tractor (see annex 4, figure 2).
- 5.10.3. Zones 1 and 2, as seen by the observer, are limited in their respective planes as follows:
- 5.10.3.1. as regards height, by two horizontal planes which are 1 m and 2.2 m respectively above the ground;
- 5.10.3.2. as regards width, by two vertical planes which make an angle of 15° towards the front and rear respectively, and towards the outside by reference to the median plane of the tractor, passing through the point (or points) of contact of vertical planes which are parallel with the median longitudinal plane of the tractor, and limiting the overall width of the tractor when on wide track.

If there are several points of contact, the one furthest towards the front shall be selected for zone 1 and the one furthest towards the rear shall be selected for zone 2.

- 5.11. The electrical connections must be such that the front and rear position (side) lamps, the end-outline marker lamps if they exist, and the rear registration plate lamp can only be switched on and off simultaneously.

This is not valid when using front and rear position (side) lamps as parking lamps.

- 5.12. The electrical connections must be such that the driving lamps and passing lamps, and the front and rear fog lamps cannot be switched on unless the lamps referred to in paragraph 5.11 are also switched on. This requirement shall not apply, however, to driving lamps or passing lamps when their luminous warnings consist of the intermittent lighting up at short intervals of the passing lamps or the intermittent lighting up of the driving lamps or the alternate lighting up at short intervals of the passing lamps and driving lamps.

The function of the circuit-closed tell-tales may be fulfilled by operational tell-tales.

5.13. Concealable lamps

- 5.13.1. The concealment of lamps shall be prohibited, with the exception of driving lamps, passing lamps, front fog-lamps and lamps to which paragraph 5.14.1 refers.

- 5.13.2. An illuminating device in the position of use shall remain in that position if the malfunction referred to in paragraph 5.13.2.1 occurs alone or in conjunction with one of the malfunctions described in paragraph 5.13.2.2.

- 5.13.2.1. The absence of power for manipulating the lamp.

- 5.13.2.2. Accidental opening of the supply circuit, earth leakage, defect in solenoids, defects in the hydraulic or compressed air lines, Bowden cables, flexible leads or other components controlling or transmitting the energy intended to actuate the concealment device.

- 5.13.3. In the event of a defect in the concealment control, or other defects referred to in paragraphs 5.13.2.1 and 5.13.2.2 above, a concealed lighting device shall be capable of being moved into the positions of use without the aid of tools.

- 5.13.4. Illuminating devices which are manipulated by power shall be brought into the position of use and switched on by means of a single control, without excluding the possibility of moving them into the position of use without switching them on. However, in the case of grouped-driving lamps and passing lamps, the control referred to above is required only to activate the passing lamps.

5.13.5. It must not be possible deliberately, from the driver's seat, to stop the movement of switched-on headlamps before they reach the position of use. If there is a danger of dazzling other road users by the movement of headlamps, they may light up only when they have reached their final position.

5.13.6. At temperatures of -30°C to $+50^{\circ}\text{C}$ an illuminating device which is manipulated by power must be capable of reaching the position of use within three seconds of initial operation of the control.

5.14. Lamps of variable position

5.14.1. The position of the direction indicator lamps, the front and rear position (side) lamps and the stop lamps may be varied, provided that:

5.14.1.1. these lamps remain attached to the tractor when their position is altered;

5.14.1.2. these lamps shall be capable of being locked in the position required by traffic conditions. Locking must be automatic.

5.15. The colours of the lamps referred to in this Regulation shall be as follows:

driving lamp:	white or selective yellow
passing lamp:	white or selective yellow
front fog lamp:	white or selective yellow (1968 Convention on Road Traffic, annex 5, appendix, footnote 3)
reversing lamp:	white
direction-indicator lamp:	amber
hazard warning signal:	amber
stop lamp:	red
rear registration plate lamp:	white
front position (side) lamp:	white (selective yellow shall be permitted if this lamp is reciprocally incorporated in a selective yellow headlamp)
rear position (side) lamp:	red

5.15.	rear fog lamp:	red
(contd)	parking lamp:	white in front, red at the rear, amber if reciprocally incorporated in the direction indicator lamps
	end outline marker lamp:	white in front, red at the rear
	work lamp:	no specification
	rear retro-reflectors:	red
	non-triangular side reflectors:	amber.

The definition of the colours of the lamps shall conform to that given in annex 5 to the Convention on Road Traffic (1968).

5.16. Every tractor submitted for approval pursuant to this Regulation shall be equipped with the following lighting and light-signalling devices:

- 5.16.1. passing lamps (para. 6.2);
 - 5.16.2. direction-indicator lamps (para. 6.5);
 - 5.16.3. hazard-warning signal (para. 6.6);
 - 5.16.4. front position (side) lamp (para. 6.8);
 - 5.16.5. rear position (side) lamp (para. 6.9);
 - 5.16.6. rear retro-reflector, non-triangular (para. 6.14);
 - 5.16.7. stop lamp (para. 6.7);
 - 5.16.8. end-outline marker light (para. 6.12) for tractors exceeding 2.1 m in width. Forbidden on all other tractors.
- 5.17. It may, in addition, be equipped with the following light-signalling devices:
- 5.17.1. driving lamp (para. 6.1);
 - 5.17.2. front fog lamp (para. 6.3);
 - 5.17.3. Reversing lamp (paragraph 6.4.)
 - 5.17.4. Rear fog-lamp (paragraph 6.10.)
 - 5.17.5. Parking lamp (paragraph 6.11.)

- 5.17.6. Work lamp (paragraph 6.13.)
- 5.17.7. Side retro reflectors, non-triangular (paragraph 6.15.)
- 5.18. The fitting of each of the lighting and light-signalling devices mentioned in paragraphs 5.16. and 5.17. above shall be effected in conformity with the relevant requirements in paragraph 6. of this Regulation.
- 5.19. The fitting of any lighting and light-signalling devices other than those mentioned in paragraphs 5.16. and 5.17. above is prohibited for the purposes of type approval. This provision does not prevent a contracting party to require or prohibit:
- 5.19.1. an approved type special warning lamp, or
- 5.19.2. an appropriate illuminating device for the rear-registration plate if it exists and its lighting is required.

6. INDIVIDUAL SPECIFICATIONS

6.1. Driving lamps

- 6.1.1. NUMBER Two or four.
- 6.1.2. ARRANGEMENT No individual specifications.
- 6.1.3. POSITION IN:
- 6.1.3.1. WIDTH The outer edges of the illuminating surface shall in no case be closer to the extreme outer edge of the tractors than the outer edges of the illuminating surface of the passing lamps.
- 6.1.3.2. HEIGHT No individual specifications.
- 6.1.3.3. LENGTH As near to the front of the tractor as possible; however, the light emitted must not in any circumstances cause discomfort to the driver either directly or indirectly through the rear-view mirrors and/or other reflecting surfaces of the tractor.

- 6.1.4. GEOMETRIC VISIBILITY The visibility of the illuminating surface, including its visibility in areas which do not appear to be illuminated in the direction of observation considered, shall be ensured within a divergent space defined by generating lines based on the perimeter of the illuminating surface and forming an angle of not less than 5° with the axis of reference of the headlamp.
- 6.1.5. ALIGNMENT Forwards. Apart from the devices necessary to maintain correct adjustment and when there are two pairs of driving lamps, one pair, consisting of headlamps functioning as driving lamp only, may swivel, according to the angle of lock on the steering, about an approximately vertical axis.
- 6.1.6. MAY BE "GROUPED" with the passing lamp and the other front lamps.
- 6.1.7. MAY NOT BE "COMBINED" with any other lamp.
- 6.1.8. MAY BE "RECIPROCALLY INCORPORATED" with the passing lamp, unless the driving lamp swivels according to the angle of lock of the steering; with the front position (side) lamp; with the front fog-lamp; with the parking lamp.
- 6.1.9. ELECTRICAL CONNECTIONS The driving lamp may be switched on either simultaneously or in pairs. For changing over from the passing to the driving beam at least one pair of driving lamps must be switched on. For changing over from the driving to the passing beam all driving lamps must be switched off simultaneously.
- The passing lamps may remain switched on at the same time as the driving lamps.
- 6.1.10. "CIRCUIT CLOSED" TELL-TALE Mandatory.

6.1.11. OTHER REQUIREMENTS

The sum of maximum intensities of driving beams which can be switched on simultaneously shall not exceed 225,000 cd. This maximum intensity shall be obtained by adding together the individual maximum intensities measured at the time of type-approval and shown on the relevant approval reports.

6.2. Passing lamps

6.2.1 NUMBER

Two. (or four - see paragraph 6.2.3.2.1.).

6.2.2. ARRANGEMENT

No individual specifications.

6.2.3. POSITION IN:

6.2.3.1. WIDTH

For tractors with a width of 1,400 mm or over, the distance of 500 mm between the projections on the inside of the passing lamps shall be observed: for agricultural tractors with a width of less than 1,400 mm: the edge of the illuminating surface furthest from the median longitudinal plane of the vehicle must not be more than 400 mm from the extreme outer edge of the vehicle;

6.2.3.2 HEIGHT ABOVE THE GROUND

if only two passing lamps are fitted:

minimum 500 mm

maximum 1,200 mm

This distance may be increased to 1,500 mm, if the height of 1,200 mm cannot be observed due to the design, taking account of the conditions of use of the tractor and its working equipment;

6.2.3.2.1.

in the case of tractors equipped for the fitting of portable devices at the front, two passing lamps in addition to the lamps mentioned in

6.2.3.2.1.
(contd)

paragraph 6.2.3.2. shall be allowed at a height not exceeding 3,000 mm if the electrical connections are such that two pairs of passing lamps cannot be switched on at the same time.

6.2.3.3. LENGTH

As near to the front of the tractor as possible; however, the light emitted must not in any circumstances cause discomfort to the driver either directly or indirectly through the rear-view mirrors and/or other reflecting surfaces of the tractor.

6.2.4. GEOMETRIC VISIBILITY

Defined by angles α and β as specified in paragraph 2.11.

α = 15° upwards and 10° downwards,

β = 45° outwards and 5° inwards.

Within this field, virtually the whole of the apparent surface of the lamp must be visible.

The presence of partitions or other items of equipment near the headlamp shall not give rise to secondary effects causing discomfort to other road users.

6.2.5. ALIGNMENT

The alignment of the passing lamps must not vary according to the angle or lock of the steering.

6.2.5.1.

If the height of the passing lamps is equal to or greater than 500 mm and equal to or less than 1,200 mm, it must be possible to lower the passing beam by between 0.5 and 4%;

6.2.5.2.

If the height of the passing lamps is greater than 1,200 but not greater than 1,500 mm, the limit of 4% laid down in paragraph 6.2.5.1. shall be increased to 6%; the passing lamps referred to in paragraph 6.2.3.2.1. must be aligned in such a way that, measured at 15 m

- 6.2.5.2. (contd) from the lamp, the horizontal line separating the lit zone from the unlit zone is situated at a height equivalent to only half the distance between the ground and the centre of the lamp.
- 6.2.6. MAY BE "GROUPED" with the driving lamps and the other front lamps.
- 6.2.7. MAY NOT BE "COMBINED" with any other lamp.
- 6.2.8. MAY BE "RECIPROCALLY INCORPORATED" with the driving lamp, unless the latter lamp swivels according to the angle of lock of the steering;
with the other front lamps.
- 6.2.9. ELECTRICAL CONNECTIONS The control for changing over to the passing beam shall switch off all driving lamps simultaneously.
The passing lamps may remain switched on at the same time as the driving beams.
- 6.2.10. "CIRCUIT CLOSED" TELL-TALE Optional.
- 6.2.11. OTHER REQUIREMENTS The requirements of paragraph 5.5.2. shall not apply to the passing lamps.
- 6.3. Front fog lamp
- 6.3.1. NUMBER Two.
- 6.3.2. ARRANGEMENT No individual specifications.
- 6.3.3. POSITION IN:
- 6.3.3.1. WIDTH No individual specifications.
- 6.3.3.2. HEIGHT No less than 250 mm above the ground.
No point on the illuminating surface shall be higher than the highest point on the illuminating surface of the passing lamp.

- 6.3.3.3. LENGTH
As near to the front of the tractor as possible; however, the light emitted must not in any circumstances cause discomfort to the driver either directly or indirectly through the rear-view mirrors and/or other reflecting surfaces of the tractor.
- 6.3.4. GEOMETRIC VISIBILITY
Defined by angles α and β as specified in paragraph 2.11.
 $\alpha = 5^\circ$ upwards and downwards;
 $\beta = 45^\circ$ outwards and 5° inwards.
- 6.3.5. ALIGNMENT
The alignment of the front fog-lamps must not vary according to the angle of lock of the steering.
They must be directed forwards without causing undue dazzle or discomfort to oncoming drivers and other road users.
- 6.3.6. MAY BE "GROUPED"
with other front lamps.
- 6.3.7. MAY NOT BE "COMBINED"
with other front lamps.
- 6.3.8. MAY BE "RECIPROCALLY INCORPORATED"
with driving lamps which do not swivel according to the angle of lock of the steering when there are four driving lamps;
with the front position (side) lamps and the parking lamps.
- 6.3.9. ELECTRICAL CONNECTIONS
It shall be possible to switch the fog lamps on or off independently of the driving lamps and passing lamps and vice versa.
- 6.3.10. "CIRCUIT CLOSED" TELL-TALE
Optional.
- 6.4. Reversing lamp
- 6.4.1. NUMBER
One or two.
- 6.4.2. ARRANGEMENT
No individual specifications.

- 6.4.3. POSITION
- 6.4.3.1. HEIGHT Not less than 250 mm and not more than 1,200 mm above the ground.
- 6.4.3.2. WIDTH No individual specifications.
- 6.4.3.3. LENGTH No individual specifications.
- 6.4.4. GEOMETRIC VISIBILITY Defined by angles α and β as specified in paragraph 2.11.
- α = 15° upwards and 5° downwards;
- β = 45° to right and to left if there is only one lamp;
- β = 45° outwards and 30° inwards if there are two.
- 6.4.5. ALIGNMENT Rearwards.
- 6.4.6. MAY BE "GROUPED" with any other rear lamp.
- 6.4.7. MAY NOT BE "COMBINED" with other lamps.
- 6.4.8. MAY NOT BE "RECIPROCALLY INCORPORATED" with other lamps.
- 6.4.9. ELECTRICAL CONNECTIONS It can only be lit up or remain alight if the reverse gear is engaged and if:
- either the engine is running;
- or one of the devices controlling the starting and stopping of the engine is in such a position that operation of the engine is possible.
- 6.4.10. TELL-TALE Optional.
- 6.5. Direction-indicator lamp (see diagrams, annex 5).
- 6.5.1. NUMBER The number of devices shall be such that they can emit signals which correspond to one of the arrangements referred to in paragraph 6.5.2.

6.5.2. . ARRANGEMENT

"A" Two front direction-indicator lamps (category 1),

Two rear direction-indicator lamps (category 2).

These lamps may be independent, grouped or combined.

"B" Two front direction-indicator lamps (category 1),

Two repeating side direction-indicator lamps (category 5),

Two rear direction-indicator lamps (category 2).

The front and repeating side lamps may be independent, grouped, or combined.

"C" Two front direction-indicator lamps (category 1),

Two rear direction-indicator lamps (category 2),

Two repeating side indicator lamps (category 5) in certain cases as specified in paragraphs 6.5.3.3.

"D" Two front direction-indicator lamps (category 1),

Two rear direction-indicator lamps (category 2).

Arrangement "A" shall be allowed only on tractors whose overall length does not exceed 4.60 m and in the case of which the distance between the outer edges of the illuminating surfaces is not more than 1.60 m.

Arrangements "B", "C" and "D" shall apply to all tractors.

6.5.2.
(contd)

The number, position and horizontal visibility of the indicator lamps shall be such that they can give indications corresponding to at least one of the arrangements defined below. The angles of visibility are hatched on the diagrams; the angles shown are minimum values which may be exceeded; all the angles of visibility are measured from the centre of the illuminating surface.

6.5.3. POSITION

6.5.3.1. WIDTH

Except in the case of category 1 direction indicator lamps of arrangement "C", the edge of the illuminating surface furthest from the median longitudinal plane of the tractor must not be more than 400mm from the extreme outer edge of the tractor. The distance between the inner edges of the two illuminating surfaces of a pair of lamps shall be not less than 500 mm. For front direction-indicator lamps the illuminating surface should be not less than 40 mm from the illuminating surface of the passing lamps or front fog-lamps, if any.

A smaller distance is permitted if the luminous intensity in the reference axis of the direction-indicator lamp is equal to at least 400 cd.

6.5.3.2. HEIGHT

Above the ground

not less than 500 mm for direction-indicator lamps in category 5,

not less than 400 mm for direction-indicator lamps in categories 1 and 2,

normally not more than 1,900 mm from all categories.

6.5.3.2.
(contd)

If the structure of the tractor makes it impossible to keep to this maximum figure, the highest point on the illuminating surface may be at 2.300 mm for direction-indicator lamps in category 5, for those in categories 1 and 2 of arrangement "A" and for those in category 1 of arrangement "B"; it may be at 2,100 mm for those in categories 1 and 2 of the other arrangements.

6.5.3.3. LENGTH

The distance between the centre of reference of the illuminating surface of the category 1 indicator (arrangement "B") and the transverse plane which marks the forward boundary of the tractor's overall length normally shall not exceed 1,800 mm. If the structure of the tractor makes it impossible to keep to the minimum angles of visibility, this distance may be increased to 2,600 mm.

In arrangement "C", the category 5 indicators are only required where the longitudinal distance between the centres of reference of the categories 1 and 2 indicators exceeds 6 m.

6.5.4. GEOMETRIC VISIBILITY

Horizontal angles: See arrangement diagrams.

In arrangements "B" and "C", the value 5° given for the dead angle of visibility to the rear of the repeating side indicator should not be exceeded. This value may be increased to 10°, however, where it is impossible to adhere to the 5° limit.

In arrangement "D" the value 10° given for the inward angle of visibility of the front indicator may be reduced to 3° for tractors with an overall width not exceeding 1,400 mm.

6.5.4.
(contd)

Vertical angles: 15° above
and below the horizontal.

The vertical angle below the horizontal may be reduced to 10° in the case of side repeating direction-indicator lamps of arrangements "B" and "C" if their height is less than 1,900 mm. The same applies in the case of direction-indicator lamps in category 1 of arrangements "B" and "D".

6.5.5. ALIGNMENT

If individual specifications for installations are laid down by the manufacturer of the lamp they must be observed.

6.5.6. MAY BE "GROUPED"

With one or more lamps, which may not be concealed.

6.5.7. MAY NOT BE "COMBINED"

With another lamp, save in accordance with the arrangements referred to in paragraph 6.5.2.

6.5.8. MAY BE "RECIPROCALLY
INCORPORATED"

With a parking lamp only, but solely in the case of direction-indicator lamps in category 5.

6.5.9. ELECTRICAL CONNECTIONS

Direction-indicator lamps shall switch on independently of the other lamps. All direction-indicator lamps on one side of a tractor shall be switched on and off by means of one control and shall flash in phase.

6.5.10. OPERATING TELL-TALE

Mandatory for all direction-indicator lamps not directly visible to the driver. It may be optical or auditory or both.

If it is optical, it shall be a flashing light which, in the event of the malfunction of any of the direction-indicator lamps other than the repeating side direction-indicator lamps, is either extinguished, or remains alight without flashing, or shows a marked

6.5.10.
(contd)

change of frequency. If it is entirely auditory, it shall be clearly audible and shall show a marked change of frequency in the event of any malfunction.

If a tractor is equipped to tow a trailer, it must be equipped with a special optical operational tell-tale for the direction indicator lamps on the trailer unless the tell-tale of the drawing vehicle allows the failure of any one of the direction-indicator lamps on the tractor combination thus formed to be detected.

6.5.11. OTHER REQUIREMENTS

The lamps shall be a flashing lamp flashing 90 ± 30 times per minute. Operation of the light-signal control shall be followed within not more than one second by the appearance of the light and within not more than one and one-half seconds by the first extinction.

If a tractor is authorized to tow a trailer, the control of the direction-indicators on the tractor shall also operate the indicators of the trailer.

In the event of failure, other than a short circuit, of one direction-indicator, the others must continue to flash but the frequency under this condition may be different from that specified.

6.6. Hazard warning signal

6.6.1. NUMBER)

)

6.6.2 ARRANGEMENT)

)

6.6.3. POSITION)

)

6.6.3.1. WIDTH)

)

6.6.3.2. HEIGHT)

)

As specified in the corresponding headings of paragraph 6.5.

- 6.6.3.3. LENGTH)
)
6.6.4. GEOMETRIC VISIBILITY)
)
6.6.5. ALIGNMENT)
)
6.6.6. MAY/MAY NOT BE "GROUPED")
)
6.6.7. MAY/MAY NOT BE "COMBINED")
)
6.6.8. MAY/MAY NOT BE "RECIPROCALLY)
 INCORPORATED")
6.6.9. ELECTRICAL CONNECTIONS The signal shall be operated by
means of a separate control enabling
all the direction-indicator lamps to
function in phase.
6.6.10. CIRCUIT-CLOSED TELL-TALE Flashing warning light, which can
operate in conjunction with the
tell-tale(s) specified in
paragraph 6.5.10.
6.6.11. OTHER REQUIREMENTS As specified in paragraph 6.5.11.
If a tractor is equipped to tow a
trailer the hazard-warning signal
control must also be capable of
activating the direction-indicator
lamps on the trailer. The hazard-
warning signal must be able to
function even if the device which
starts or stops the engine is in a
position which makes it impossible
to start the engine.
6.7. Stop lamp
6.7.1. NUMBER Two.
6.7.2. ARRANGEMENT No individual specifications.
6.7.3. POSITION
6.7.3.1. WIDTH Not less than 500 mm apart. This
distance may be reduced to 400 mm if
the overall width of the tractor is
less than 1,400 mm.

- 6.7.3.2. HEIGHT Above the ground: not less than 400 mm and not more than 1,900 mm, or not more than 2,100 mm if the structure of the vehicle makes it impossible to keep within 1,900 mm.
- 6.7.3.3. LENGTH No individual specification.
- 6.7.4. GEOMETRIC VISIBILITY Horizontal angle: "45°" outwards and inwards.
Vertical angle: 15° above and below the horizontal.
The vertical angle below the horizontal may be reduced to 10° if the lamp is situated less than 1,500 mm above ground, to 5° in the case of lamps less than 750 mm above the ground.
- 6.7.5. ALIGNMENT Towards the rear of the vehicle.
- 6.7.6. MAY BE "GROUPED" with one or more other rear lamps.
- 6.7.7. MAY NOT BE "COMBINED" with another lamp.
- 6.7.8. MAY BE "RECIPROCALLY INCORPORATED" with the rear position (side) lamp and the parking lamp.
- 6.7.9. ELECTRICAL CONNECTIONS shall light up when the service brake is applied.
- 6.7.10. OPERATIONAL TELL-TALE Optional. If fitted, it shall be a non-flashing warning lamp which comes on in the event of the malfunctioning of the stop lamps.
- 6.7.11. OTHER REQUIREMENTS The luminous intensity of the stop lamps shall be markedly greater than that of the rear position (side) lamps.
- 6.8. Front position (side) lamp
- 6.8.1. NUMBER Two or four (see paragraph 6.8.3.2.).
- 6.8.2. ARRANGEMENT No individual specifications

6.8.3. POSITION

6.8.3.1. WIDTH

That point on the illuminating surface which is farthest from the tractor's median longitudinal plane shall be not more than 400 mm from the extreme outer edge of the vehicle.

The clearance between the respective inner edges of the two illuminating surfaces shall be not less than 500 mm.

6.8.3.2. HEIGHT

Above the ground, not less than 400 mm, not more than 1,900 mm or not more than 2,100 mm if the shape of the bodywork makes it impossible to keep within the 1,900 prescribed above.

In the case of tractors equipped for the fitting of portable devices at the front, which may obscure the mandatory front position (side) lamps, two additional front position (side) lamps may be fitted at a height not exceeding 3,000 mm.

6.8.3.3. LENGTH

No specifications provided that the lamps are aligned forwards and the angles of geometrical visibility specified in paragraph 6.8.4. are complied with.

6.8.4. GEOMETRIC VISIBILITY

Horizontal angle

For the two front position (side) lamps: 10° inwards and 80° outwards. However, the angle of 10° inwards may be reduced to 5° if the shape of the bodywork makes it impossible to keep to 10°. For tractors with any overall width not exceeding 1,400 mm this angle may be reduced to 3° if the shape of the bodywork makes it impossible to keep to 10°.

- 6.8.4. (contd) Vertical angle
15° above and below the horizontal.
The vertical angle below the horizontal may be reduced to 10° if the height of the lamp above the ground is less than 1,900 mm, and to 5° if this height is less than 750 mm.
- 6.8.5. ALIGNMENT Towards the front.
- 6.8.6. MAY BE "GROUPED" with any other front lamp.
- 6.8.7. MAY NOT BE "COMBINED" with other lamps.
- 6.8.8. MAY BE "RECIPROCALLY INCORPORATED" with any other front lamps.
- 6.8.9. ELECTRICAL CONNECTIONS No individual specifications.
- 6.8.10. TELL-TALE Mandatory. This tell-tale shall be non-flashing. It shall not be required if the instrument panel lighting can only be turned on simultaneously with the front position (side) lamps.
- 6.9. Rear position (side) lamp
- 6.9.1. NUMBER Two.
- 6.9.2. ARRANGEMENT No individual specifications.
- 6.9.3. POSITION
- 6.9.3.1. WIDTH That point on the illuminating surface which is farthest from the tractor's median longitudinal plane shall be not more than 400 mm from the extreme outer edge of the tractor.
- The distance between the inner edges of the two illuminating surfaces shall be not less than 500 mm. This distance may be reduced to 400 mm where the overall width of the tractor is less than 1,400 mm.

- 6.9.3.2. HEIGHT Above the ground not less than 400 mm and not more than 1,900 mm (in exceptional cases not more than 2,100 mm if it is impossible to keep within 1,900 mm).
- 6.9.3.3. LENGTH No individual specification.
- 6.9.4. GEOMETRIC VISIBILITY Horizontal angle
- For the two rear position (side) lamps:
- either 45° inwards and 80° outwards,
- or 80° inwards and 45° outwards.
- Vertical angle
- 15° above and below the horizontal. The angle below the horizontal may be reduced to 10° if the height of the lamp above the ground is less than 1,500 mm, and to 5° if this height is less than 750 mm.
- 6.9.5. ALIGNMENT Towards the rear.
- 6.9.6. MAY BE "GROUPED" with any other rear lamp.
- 6.9.7. MAY BE "COMBINED" with the rear registration-plate lamp.
- 6.9.8. MAY BE "RECIPROCALLY INCORPORATED" with the stop lamps, the rear fog-lamp or the parking lamp.
- 6.9.9. ELECTRICAL CONNECTIONS No individual specifications.
- 6.9.10. "CIRCUIT CLOSED" TELL-TALE Must be combined with that of the front position (side) lamps. This tell-tale shall be non-flashing. It shall not be required if the instrument panel lighting can only be turned on simultaneously with the front (side) position lamp.
- 6.10. Rear fog-lamp
- 6.10.1. NUMBER One or two.

- 6.10.2. ARRANGEMENT This must satisfy the conditions of geometric visibility.
- 6.10.3. POSITION
- 6.10.3.1. WIDTH If there is only one rear fog lamp, it must be in the median longitudinal plane of the tractor, or on the opposite side of the median longitudinal plane to the direction of traffic prescribed in the country of registration. In all cases the distance between the rear fog-lamp and the stop lamp shall be more than 100 mm.
- 6.10.3.2. HEIGHT Above the ground, not less than 250 mm, not more than 1,900 mm, or not more than 2,100 mm if the shape of the bodywork makes it impossible to keep within 1,900 mm.
- 6.10.3.3. LENGTH No individual specification.
- 6.10.4. GEOMETRIC VISIBILITY Horizontal angle: 25° inwards and outwards.
Vertical angle: 5° above and below the horizontal.
- 6.10.5. ALIGNMENT Towards the rear.
- 6.10.6. MAY BE "GROUPED" with any other rear lamp.
- 6.10.7. MAY NOT BE "COMBINED" with other lamps.
- 6.10.8. MAY BE "RECIPROCALLY INCORPORATED" with the rear position (side) lamps or the parking lamp.
- 6.10.9. ELECTRICAL CONNECTIONS These must be such that the rear fog-lamp can operate only when the passing lamps or driving lamps and front fog-lamps or a combination of these are switched on. They must be such that when the rear fog-lamp is switched on it is capable of operating together with the driving lamps, the passing lamps and the front fog-lamps. When the rear fog-lamp is switched on, operating

- 6.10.9. (contd) the driving or passing lamps control shall not extinguish the rear fog-lamp.
- If the front fog-lamps exist, the extinguishing of the rear fog-lamp must be possible independently from that of the front fog-lamps.
- 6.10.10. "CIRCUIT CLOSED" TELL-TALE Mandatory. An independent, fixed-intensity signal light.
- 6.11. Parking lamp
- 6.11.1. NUMBER Dependent upon the arrangement.
- 6.11.2. ARRANGEMENT either two front lamps and two rear lamps, or one lamp on each side.
- 6.11.3. POSITION
- 6.11.3.1. WIDTH That point on the illuminating surface which is farthest from the tractor's median longitudinal plane shall not be more than 400 mm from the extreme outer edge of the tractor. Furthermore, in the case of a pair of lamps, the lamps must be symmetrical to the median longitudinal plane of the tractor.
- 6.11.3.2. HEIGHT Above the ground, not less than 400 mm and not more than 1,900 mm (not more than 2,100 mm if the design of the bodywork makes it impossible to keep within 1,900 mm).
- 6.11.3.3. LENGTH No individual specifications.
- 6.11.4. GEOMETRIC VISIBILITY Horizontal angle: 45° outwards, towards the front and towards the rear.
- Vertical angle: 15° above and below the horizontal. The vertical angle below the horizontal may be reduced to 10° if the height of the lamp above the ground is less than 1,900 mm; and to 5° if this height is less than 750 mm.

- 6.11.5. ALIGNMENT Such that the lamps meet the requirements concerning visibility towards the front and towards the rear.
- 6.11.6. MAY BE "GROUPED" with any other lamp.
- 6.11.7. MAY NOT BE "COMBINED" with other lamps.
- 6.11.8. MAY BE "RECIPROCALLY INCORPORATED" at the front with the front position (side) lamps, the passing lamps, the driving lamps and the front fog-lamps,

at the rear, with the rear position (side) lamps, the stop lamps and the rear fog-lamps.

with the direction indicator lamps in category 5.
- 6.11.9. ELECTRICAL CONNECTIONS The connections must allow the parking lamp(s) on the same side of the tractor to be lit independently of any other lamps.
- 6.11.10. TELL-TALE Optional. If there is one, it must not be possible to confuse it with the tell-tale for the position (side) lamps.
- 6.11.11. OTHER REQUIREMENTS The function of this lamp may also be performed by the simultaneous switching on of the front and rear position (side) lamps on one side of the tractor.
- 6.12. End-outline marker lamp
- 6.12.1. NUMBER Two visible from the front and two visible from the rear.
- 6.12.2. ARRANGEMENT No individual specifications.
- 6.12.3. POSITION
- 6.12.3.1. WIDTH As close as possible to the extreme outer edge of the tractor.

- 6.12.3.2. HEIGHT At the greatest height compatible with the required position in width and with symmetry of the lamps.
- 6.12.3.3. LENGTH No individual specification.
- 6.12.4. GEOMETRIC VISIBILITY Horizontal angle: 80° outwards.
Vertical angle: 5° above and 20° below the horizontal.
- 6.12.5. ALIGNMENT Such that the lamps meet the requirements concerning visibility towards the front and towards the rear.
- 6.12.6. MAY NOT BE "GROUPED")
6.12.7. MAY NOT BE "COMBINED")
6.12.8. MAY NOT BE "RECIPROCALLY)
INCORPORATED") with other lamps.
- 6.12.9. ELECTRICAL CONNECTIONS No individual specifications.
- 6.12.10. TELL-TALE Mandatory.
- 6.12.11. OTHER REQUIREMENTS Subject to all the other conditions being met, the lamp visible from in front and the lamp visible from the rear, on the same side of the tractor, may be included in one device. The position of an end-outline marker lamp in relation to the corresponding position (side) lamp shall be such that the distance between the projections on a transverse vertical plane of the points nearest to one another of the illuminating surfaces of the two lamps considered is not less than 200 mm.
- 6.13. Work lamp
- 6.13.1. NUMBER)
6.13.2. ARRANGEMENT)
6.13.3. POSITION) No individual specifications.
)

- 6.13.4. GEOMETRIC VISIBILITY)
)
6.13.5. ALIGNMENT)
6.13.6. MAY NOT BE "GROUPED")
)
6.13.7. MAY NOT BE "COMBINED")
)
6.13.8. MAY NOT BE "RECIPROCALLY) with another lamp.
INCORPORATED")
6.13.9. ELECTRICAL CONNECTIONS This lamp may be operated
independently of all other lamps.
6.13.10. TELL-TALE Mandatory.
6.14. Rear retro reflector, non triangular
6.14.1. NUMBER Two or four.
6.14.2. ARRANGEMENT No individual specifications.
6.14.3. POSITION
6.14.3.1. WIDTH Except as provided in
paragraph 6.14.4.1. the point on the
illuminating surface which is
farthest from the tractor's median
longitudinal plane shall be not more
than 400 mm from the extreme outer
edge of the tractor. The inner
edges of the reflex reflectors shall
be not less than 600 mm apart. This
distance may be reduced to 400 mm
where the overall width of the
tractor is less than 1,300 mm.
6.14.3.2. HEIGHT Except as provided in
paragraph 6.14.4.1, not less than
400 mm and not more than 900 mm
above the ground. However, the
upper limit may be increased to not
more than 1,200 mm if it is
impossible to keep within the height
of 900 mm without having to use
fixing devices liable to be easily
damaged or bent.
6.14.3.3. LENGTH No individual specifications.

6.14.4. GEOMETRIC VISIBILITY

Horizontal angle.

30° inwards and outwards.

Vertical angle.

15° above and below the horizontal.
The vertical angle below the horizontal may be reduced to 5° if the height of the reflector is less than 750 mm.

6.14.4.1.

If it is impossible to observe the above position and visibility requirements, four retro reflectors may be fitted in accordance with the following installation specifications:

6.14.4.1.1.

Two retro reflectors must keep within the maximum height of 900 mm above the ground. However, this upper limit may be increased to not more than 1,200 mm if it is impossible to keep within the height of 900 mm without having to use fixing devices liable to be easily damaged or bent.

A distance of at least 300 mm between the interior edges of the reflectors must be observed, and they must have a vertical angle of visibility above the horizontal of 15°.

6.14.4.1.2.

The other two shall keep within a maximum height of 2,100 mm above the ground and shall be bound by the requirements of paragraph 6.14.3.1.

6.14.5. ALIGNMENT

Towards the rear.

6.14.6. MAY BE "GROUPED"

With any other lamp.

6.14.7. OTHER REQUIREMENTS

The illuminating surface of the retro reflector may have parts in common with that of any other rear lamp.

- 6.15. Side retro reflectors, non triangular
- 6.15.1. NUMBER Two or four.
- 6.15.2. ARRANGEMENT One or two each side of tractor where over-all length of tractor \leq 6 m. Two each side of tractor where over-all length of tractor $>$ 6 m. The reflecting surface must be mounted in a vertical plane (maximum deviation 10°) parallel to the longitudinal axis of the vehicle.
- 6.15.3. POSITION
- 6.15.3.1. WIDTH No individual specification.
- 6.15.3.2. HEIGHT Not less than 400 mm and not more than 900 mm above the ground. However, the upper limit may be increased to not more than 1,200 mm if it is impossible to keep within the height of 900 mm without having to use fixing devices liable to be easily damaged or bent.
- 6.15.3.3. LENGTH One reflector must be not more than 3 m from the foremost point of the tractor, and either the same reflector or a second reflector must be not more than 3 m from the rearmost point of the tractor.
- The distance between two reflectors on the same side of the tractor must not exceed 6 m.
- 6.15.4. GEOMETRIC VISIBILITY Horizontal angle.
- 20° forwards and rearwards.
- Vertical angle.
- 10° above and below the horizontal.
- The vertical angle below the horizontal may be reduced to 5° if the length of the reflector is less than 750 mm.

- 6.16. Rear registration plate lamp
- 6.16.1. NUMBER)
6.16.2. ARRANGEMENT)
6.16.3. POSITION)
6.16.3.1. WIDTH) Such that the device is able to
6.16.3.2. HEIGHT) illuminate the site of the
6.16.3.3. LENGTH) registration plate
6.16.4. GEOMETRIC VISIBILITY)
6.16.5. ALIGNMENT)
- 6.16.6. MAY BE "GROUPED" with one or more rear lamps.
- 6.16.7. MAY BE "COMBINED" with the rear position (side) lamps.
- 6.16.8. MAY NOT BE "RECIPROCALLY with any other lamp.
INCORPORATED"
- 6.16.9. TELL-TALE Optional. If provided, its function shall be performed by the tell-tale prescribed for the front and rear position (side) lamps.
- 6.16.10. ELECTRICAL CONNECTIONS The device shall light up only at the same time as the rear position (side) lamps.
7. MODIFICATION AND EXTENSION OF APPROVAL OF THE VEHICLE TYPE OR OF THE INSTALLATION OF ITS LIGHTING AND LIGHT-SIGNALLING DEVICES
- 7.1. Every modification of the vehicle type, or of the installation of its lighting or light-signalling devices, or of the list referred to in paragraph 3.2 above, shall be communicated to the administrative department which approved that vehicle type. The department may then either:
- 7.1.1. consider that the modifications made are unlikely to have an appreciable adverse effect and that in any case the vehicle still meets the requirements; or
- 7.1.2. require a further test report from the technical service responsible for conducting the tests.

7.2. Confirmation or refusal of approval, specifying the alterations, shall be communicated by the procedure specified in paragraph 4.3. above to the Parties to the Agreement applying this Regulation.

7.3. The competent authority issuing the extension of approval shall assign a series number for such an extension and inform thereof the other Parties to the 1958 Agreement applying this Regulation by means of a communication form conforming to the model in annex 1 to this Regulation.

8. CONFORMITY OF PRODUCTION

8.1. Every vehicle bearing an approval mark as prescribed by this Regulation shall conform, as regards the installation of lighting and light-signalling devices and their characteristics, to the vehicle type approved.

8.2. In order to verify conformity as prescribed in paragraph 8.1. above, a sufficient number of random checks shall be made on serially manufactured vehicles bearing the approval mark required by this Regulation.

9. PENALTIES FOR NON-CONFORMITY OF PRODUCTION

9.1. The approval granted in respect of a vehicle type pursuant to this Regulation may be withdrawn if the requirements laid down in paragraph 8.1. above are not complied with or if the vehicle or vehicles taken fail to pass the tests prescribed in paragraph 8, above.

9.2. If a Party to the Agreement applying this Regulation withdraws an approval it has previously granted, it shall forthwith so notify the other Contracting Parties applying this Regulation, by means of a communication form conforming to the model in annex 1 to this Regulation.

10. PRODUCTION DEFINITELY DISCONTINUED

If the holder of the approval completely ceases to manufacture a type of vehicle under the Regulation, he shall inform thereof the authority which granted the approval. Upon receiving the relevant communication that authority shall inform the other Contracting Parties which apply this Regulation thereof, by means of a communication form conforming to the model in annex 1 to this Regulation.

11. NAMES AND ADDRESSES OF TECHNICAL SERVICES RESPONSIBLE FOR
CONDUCTING APPROVAL TESTS, AND OF ADMINISTRATIVE DEPARTMENTS

The Parties to the Agreement applying this Regulation shall communicate to the United Nations Secretariat the names and addresses of the technical services responsible for conducting approval tests and of the administrative departments which grant approval and to which forms certifying approval or extension or refusal or withdrawal of approval or production definitely discontinued, issued in other countries, are to be sent.

Explanatory figure

(see paragraph 2.11)

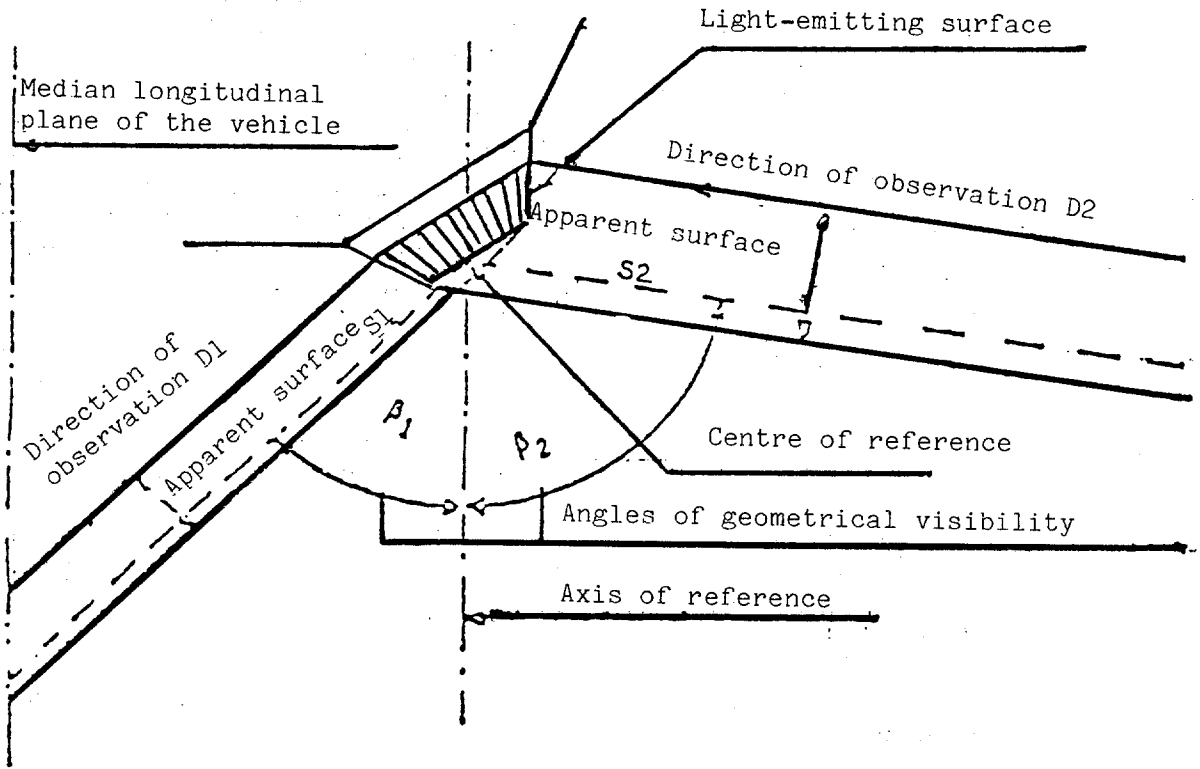

Annex 1

COMMUNICATION

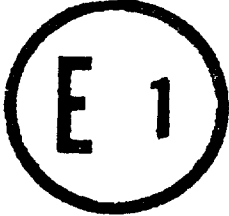

issued by: Name of Administration:
.....
.....
.....

(maximum format: A4 (210 x 297))

- concerning APPROVAL GRANTED
- APPROVAL EXTENDED
- APPROVAL REFUSED
- APPROVAL WITHDRAWN
- PRODUCTION DEFINITELY DISCONTINUED

of a type of agricultural or forestry tractor with regard to the installation of lighting and light-signalling devices pursuant to Regulation No. 86

Approval No. Extension No.

1. Make (trade name)
2. Tractor type and commercial description classification
3. Manufacturer's name and address
4. If applicable, name and address of manufacturer's representative
5. Lighting equipment installed on the tractor submitted for approval 1/2/
.....
 - 5.1. Driving lamps: yes/no 3/
 - 5.2. Passing lamps: yes/no 3/

- 5.3. Front fog-lamps: yes/no 3/
- 5.4. Reversing lamps: yes/no 3/
- 5.5. Front direction-indicator lamps: yes/no 3/
- 5.6. Rear direction-indicator lamps: yes/no 3/
- 5.7. Repeating side indicator lamps: yes/no 3/
- 5.8. Hazard-warning signal: yes/no 3/
- 5.9. Stop lamps: yes/no 3/
- 5.10. Rear registration-plate lamp: yes/no 3/
- 5.11. Front position (side) lamps: yes/no 3/
- 5.12. Rear position (side) lamps: yes/no 3/
- 5.13. Rear fog-lamps: yes/no 3/
- 5.14. Parking lamps: yes/no 3/
- 5.15. End-outline marker lamps: yes/no 3/
- 5.16. Rear retro reflectors, non-triangular: yes/no 3/
- 5.17. Work lamps: yes/no 3/
- 5.18. Side retro reflectors, non triangular: yes/no 3/
6. Equivalent lamps: yes/no 3/ (see paragraph 2.6.1.)
7. Maximum technically permissible width of the tractor:
8. Tractor submitted for approval on
9. Technical service responsible for conducting approval tests
-
10. Date of report issued by that service
11. Number of report issued by that service
12. Approval with regard to the lighting and light-signalling devices is granted/extended/refused/withdrawn 3/

- 13. Position of approval mark on tractor
-
- 14. Place
- 15. Date
- 16. Signature
- 17. Remarks
-
-
-
-
-

Notes

1/ Distinguishing number of the country which has granted/extended/
refused/withdrawn approval (see approval provisions in the Regulation).

2/ Show for each device, on a separate form, the types of devices, duly
identified, meeting the installation requirements of this Regulation.

3/ Strike out what does not apply.

Annex 2

EXAMPLES OF ARRANGEMENTS OF APPROVAL MARKS

Model A

(See paragraph 4.4. of this Regulation)

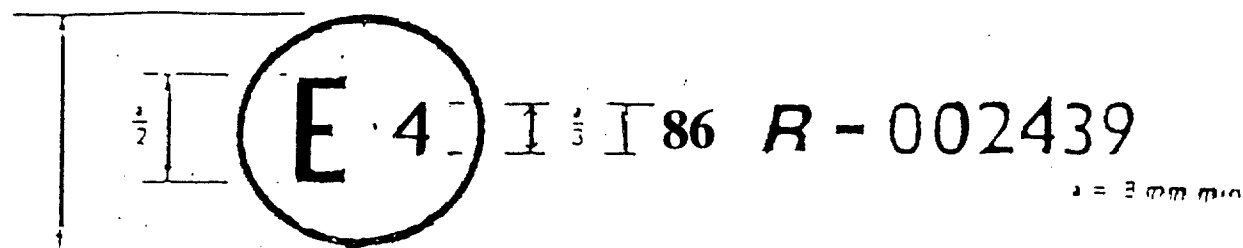

The above approval mark affixed to an agricultural or forestry tractor shows that the tractor type concerned has, with regard to the installation of lighting and light-signalling devices, been approved in the Netherlands (E 4) pursuant to Regulation No. 86. The approval number indicates that the approval was granted in accordance with the requirements of Regulation No. 86 in its original form.

Model B

(See paragraph 4.5. of this Regulation)

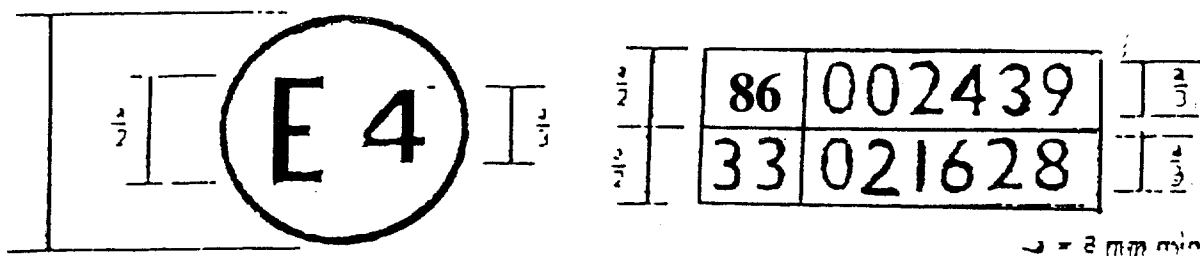

The above approval mark affixed to an agricultural or forestry tractor shows that the tractor type concerned has been approved in the Netherlands (E 4) pursuant to Regulations Nos. 86 and 33.* The approval numbers indicate that, at the dates when the respective approvals were given, Regulation No. 86 was in its original form and Regulation No. 33 already included the 02 series of amendments.

* The latter number is given as an example only.

Annex 3

DEFINITION OF THE TERMS OF PARAGRAPHS 2.7 - 2.11

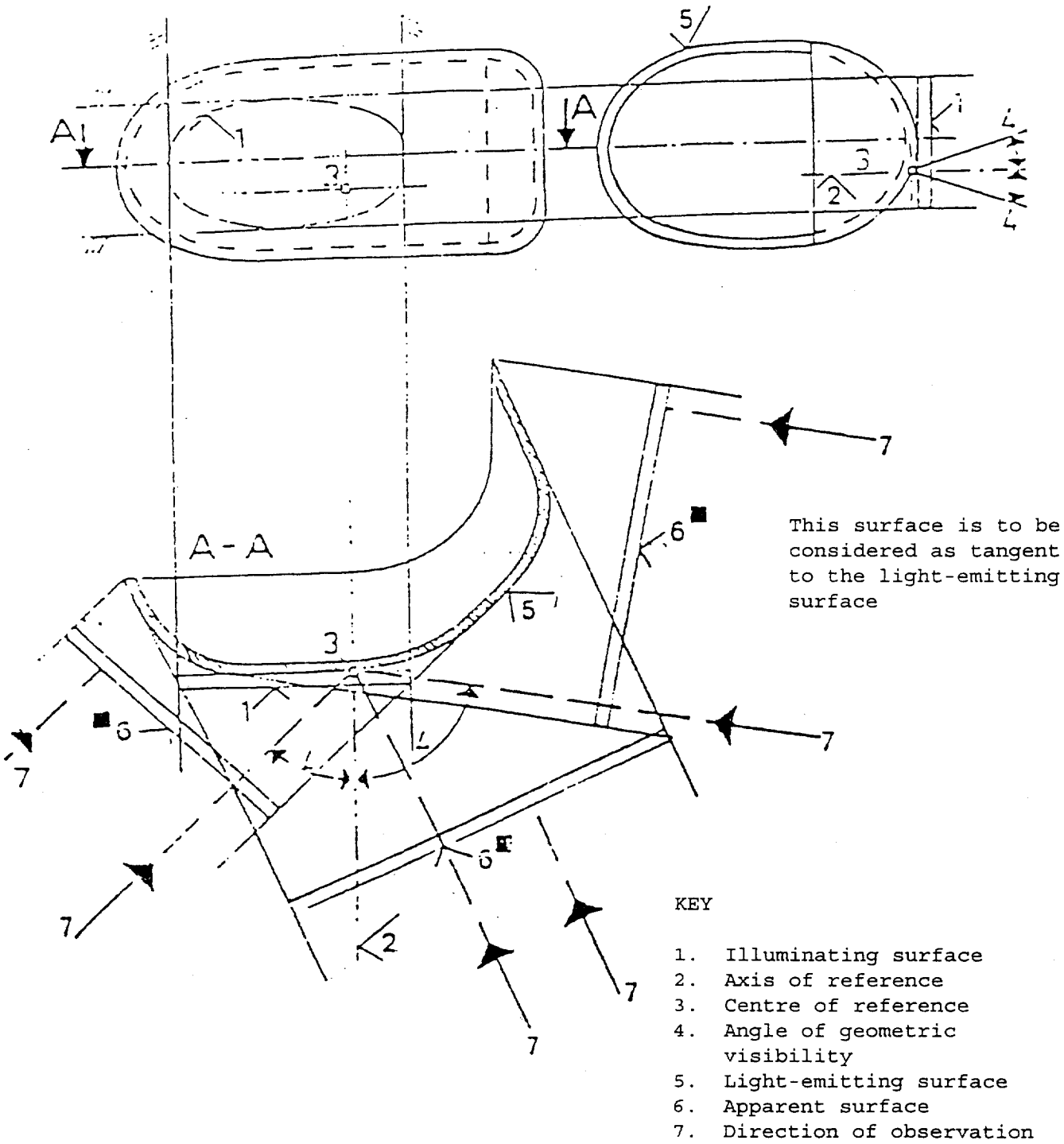

Annex 4

VISIBILITY OF LAMPS

(see paragraph 5.10. of this Regulation)

Fig. 1 Visibility of a red lamp
to the front

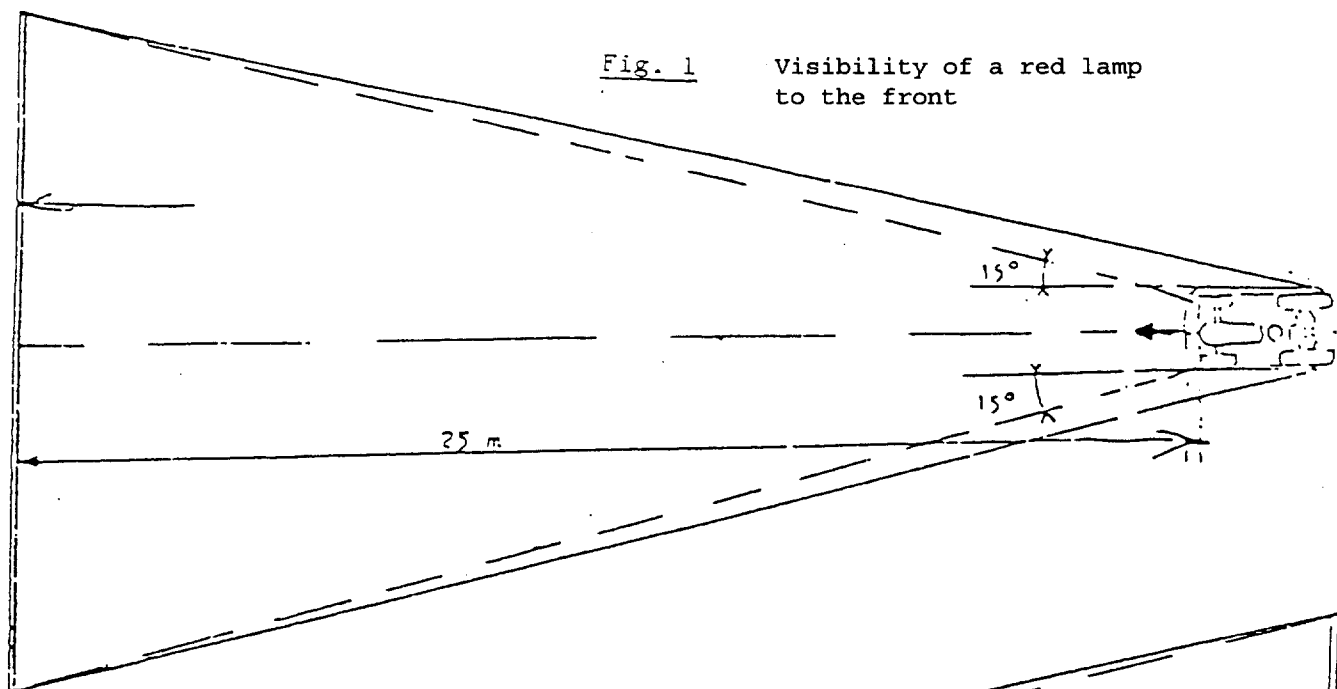
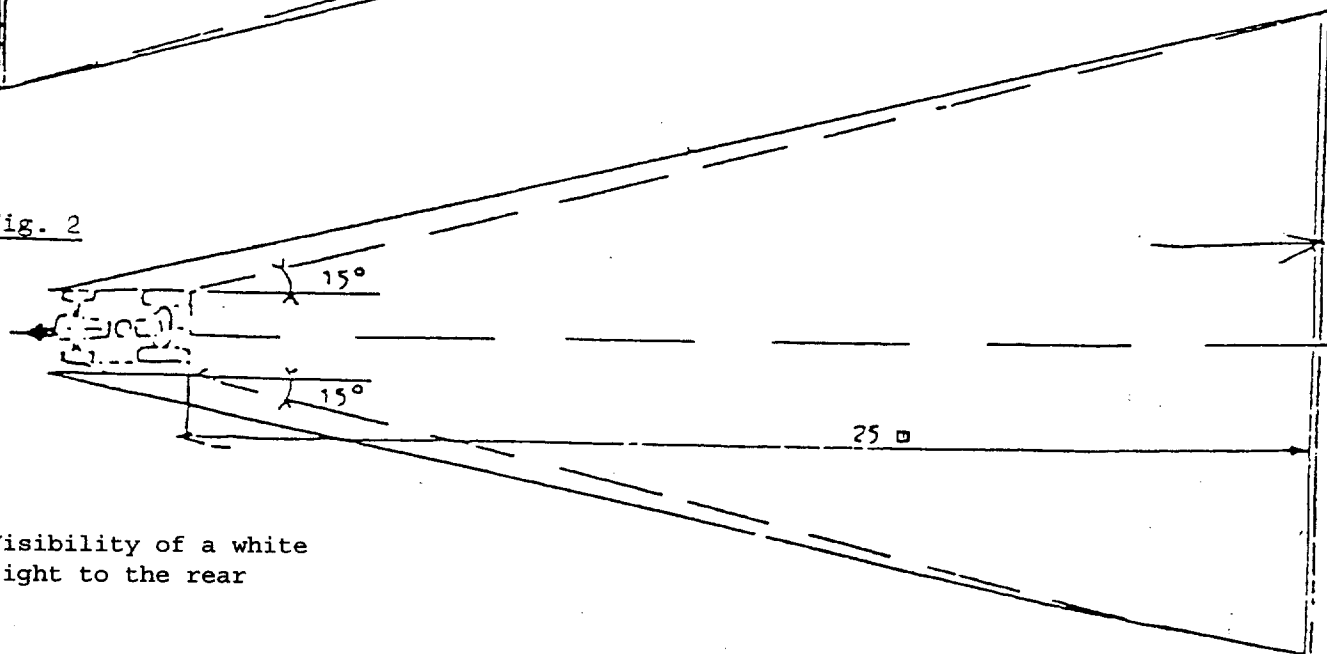

Fig. 2



Visibility of a white
light to the rear

