

3 July 1998

AGREEMENT

**CONCERNING THE ADOPTION OF UNIFORM TECHNICAL PRESCRIPTIONS
FOR WHEELED VEHICLES, EQUIPMENT AND PARTS WHICH CAN BE FITTED AND/OR
BE USED ON WHEELED VEHICLES AND THE CONDITIONS FOR RECIPROCAL RECOGNITION
OF APPROVALS GRANTED ON THE BASIS OF THESE PRESCRIPTIONS */**

(Revision 2, including the amendments entered into force on 16 October 1995)

Addendum 105: Regulation No. 106

Date of entry into force: 7 May 1998

**UNIFORM PROVISIONS CONCERNING THE APPROVAL OF PNEUMATIC TYRES
FOR AGRICULTURAL VEHICLES AND THEIR TRAILERS**



UNITED NATIONS

*/ Former title of the Agreement:

Agreement Concerning the Adoption of Uniform Conditions of Approval and Reciprocal Recognition of Approval for Motor Vehicle Equipment and Parts, done at Geneva on 20 March 1958.

GE.98- 21706

Regulation No. 10

UNIFORM PROVISIONS CONCERNING THE APPROVAL OF PNEUMATIC TYRES
FOR AGRICULTURAL VEHICLES AND THEIR TRAILERS

CONTENTS

	<u>Page</u>
REGULATION	
1. Scope	5
2. Definitions	5
3. Markings	11
4. Application for approval	12
5. Approval	13
6. Requirements	14
7. Modification of tyre type and extension of approval	17
8. Conformity of production	18
9. Penalties for non-conformity of production	18
10. Production definitely discontinued	18
10. Names and addresses of technical services responsible for conducting approval tests, of test laboratories, and of administrative departments	18
ANNEXES	
<u>Annex 1</u> - Communication concerning the approval or extension or refusal or withdrawal of approval or production definitely discontinued of a type of pneumatic tyre for motor vehicles pursuant to Regulation No. 106	
<u>Annex 2</u> - Arrangement of approval mark	
<u>Annex 3</u> - Arrangement of tyre markings	
<u>Annex 4</u> - List of load capacity indices (LI) and corresponding maximum mass to be carried (kg)	

CONTENTS (continued)

- Annex 5 - Theoretical rim, outer diameter and nominal section width of tyres of certain size designations
 - Annex 6 - Test method for measuring tyre dimensions
 - Annex 7 - Variation of load capacity with speed
 - Annex 8 - Test procedure to assess tyre resistance to bursting
 - Annex 9 - Load/speed test procedure
 - Annex 10 - Tyre classification code
 - Annex 11 - Example of the pictogram to be marked on both tyre sidewalls of the tyres to explicit the maximum inflation pressure not to be exceeded for bead seating during tyre mounting
-

1. SCOPE

This Regulation covers new pneumatic tyres designed primarily, but not only, for agricultural and forestry vehicles (power-driven vehicles in category T), agricultural machines (power-driven and trailed) and agricultural trailers, and identified by speed category symbols corresponding to speeds of 65 km/h (speed symbol 'D') and below.

It does not apply to tyre types designated primarily for other purposes, such as:

- (a) Construction application (tyres marked "Industrial" or "IND" or "R4" or "F3");
- (b) Earth-moving equipment;
- (c) Industrial and lift trucks.

2. DEFINITIONS

For the purposes of this Regulation:

- 2.1. "Type of agricultural tyre" means a category of tyres which do not differ in such essential respects as:
- 2.1.1. the manufacturer;
 - 2.1.2. tyre-size designation;
 - 2.1.3. category of use:
 - Tractor - Steering wheel;
 - Tractor - Drive wheel - standard tread
 - Tractor - Drive wheel - special tread
 - Implement - traction;
 - Implement - trailer;
 - Implement - mixed applications
 - 2.1.4. structure (diagonal (bias-ply), bias-belted, radial-ply);
 - 2.1.5. speed category symbol;
 - 2.1.6. load capacity index;
 - 2.1.7. tyre cross-section;
- 2.2. For reference on the following terms see explanatory figure in appendix 1.
- 2.3. "Structure" of a tyre means the technical characteristics of the tyre carcass. The following structures are distinguished in particular:

- 2.3.1. "Diagonal" or "bias-ply" describes a tyre structure in which the ply cords extend to the bead and are laid at alternate angles of substantially less than 90° to the centreline of the tread;
- 2.3.2. "Bias-belted" describes a tyre structure of diagonal (bias-ply) type in which the carcass is restricted by a belt comprising two or more layers of substantially inextensible cord material laid at alternate angles close to those of the carcass;
- 2.3.3. "Radial" describes a tyre structure in which the ply cords extend to the beads and are laid substantially at 90° to the centreline of the tread, the carcass being stabilised by an essentially inextensible circumferential belt;
- 2.4. "Bead" means the part of a tyre which is of such shape and structure as to fit the rim and hold the tyre on it;
- 2.5. "Cord" means the strands forming the fabric of the plies in the tyre;
- 2.6. "Ply" means a layer of rubber-coated parallel cords;
- 2.7. "Carcass" means that part of a tyre other than the tread and the rubber sidewalls which, when inflated, bears the load;
- 2.8. "Tread" means that part of a tyre which comes into contact with the ground;
- 2.9. "Sidewall" means the part of the tyre, excluding the tread, which is visible when the tyre, fitted to a rim, is viewed from the side;
- 2.10. "Section width (S)" means the linear distance between the outsides of the sidewalls of an inflated tyre, excluding elevations due to labelling (marking), decoration or protective bands or ribs;
- 2.11. "Overall width" means the linear distance between the outside of the sidewalls of an inflated tyre, including labelling (marking), decoration and protective bands or ribs;
- 2.12. "Section height (h)" means a distance equal to half the difference between the outer diameter of the tyre and the nominal rim diameter;
- 2.13. "Nominal aspect ratio (Ra)" means one hundred times the number obtained by dividing the number expressing the nominal section height in millimetres by the number expressing the nominal section width in millimetres;
- 2.14. "Outer diameter (D)" means the overall diameter of an inflated new tyre;

- 2.15. "Tyre-size designation" means a designation showing:
- 2.15.1. the nominal section width (S1). This value must be expressed in mm.
 - 2.15.2. the nominal aspect ratio (Ra).
 - 2.15.3. an indication of the structure, placed in front of the nominal rim diameter marking, as follows:
 - 2.15.3.1. on diagonal (bias-ply) tyres, the symbol "-" or the letter "D";
 - 2.15.3.2. on radial-ply tyres, the letter "R";
 - 2.15.3.3. on bias-belted tyres, the letter "B".
 - 2.15.4. the conventional number "d" denoting the nominal rim diameter;
 - 2.15.5. optionally, the letters "IMP" after the nominal rim diameter marking in case of Implement tyres;
 - 2.15.6. optionally, the letters "FRONT" or "SL" after the nominal rim diameter marking in case of Tractor steering wheel tyres;
 - 2.15.7. However for tyres listed in annex 5 the "tyre size designation" is that shown in the first column of those tables.
- 2.16. "Nominal rim diameter (d)" means a conventional number denoting the nominal diameter of the rim on which a tyre is designed to be mounted and corresponding to the diameter of the rim expressed either by size codes (number below 100 - see table for equivalence with millimeters) or in mm (numbers above 100) but not both;

"d" symbol expressed by codes	value to be used for the calculation in paras. 4.2.1 and 4.4 (mm)
4	102
5	127
6	152
7	178
8	203
9	229
10	254
11	279
12	305
13	330
14	356
15	381
15.3	389
16	406
16.1	409
17	432

"d" symbol expressed by codes	value to be used for the calculation in paras. 4.2.1 and 4.4 (mm)
18	457
19	483
20	508
21	533
22	559
24	610
26	660
28	711
30	762
32	813
34	864
36	914
38	965
40	1016
42	1067
44	1118

"d" symbol expressed by codes	value to be used for the calculation in paras. 4.2.1 and 4.4 (mm)
46	1168
48	1219
50	1270
52	1321
54	1372
14.5	368
15.5	394
16.5	419
17.5	445
19.5	495
20.5	521
22.5	572
24.5	622
26.5	673
30.5	775

- 2.17. "Rim" means the support for a tyre-and-tube assembly, or for a tubeless tyre, on which the tyre beads are seated;
- 2.18. "Theoretical rim" means the notional rim whose width would be equal to X times the nominal section width of a tyre; the value "X" must be specified by the tyre manufacturer or the reference rim width is that mentioned in annex 5 for the relevant "tyre size designation";
- 2.19. "Measuring rim" means the rim on which a tyre is fitted for the measurement of the dimensions;
- 2.20. "Tractor-drive wheel tyre" means a tyre designed to be fitted to driven axles of agricultural and forestry tractors (vehicles in categories T) suitable for sustained high torque service. The tread pattern of the tyre consists of lugs or cleats.
- 2.21. "Tractor steering wheel tyre" means a tyre designed to be fitted to non-driven axles of agricultural and forestry tractors (motor vehicles in category T); The tread pattern of the tyre generally consists of circumferential grooves and ribs.
- 2.22. "Implement tyre" means a tyre designed primarily for agricultural machines or implements (vehicles in category S) or for agricultural trailers (vehicles in category R); however it may also equip either front steering wheels and drive wheels of agricultural and forestry

tractors (vehicles in category T), but it is not suitable for sustained high torque services.

2.23. "Traction tyre" means a tyre designed primarily for the equipment of driven axles of implements or agricultural machinery, excluding sustained high torque services. The tread pattern of the tyre generally consists of lugs or cleats. The type of application is identified with the symbol: 

2.24. "Trailer tyre" means a tyre designed for the equipment of non driven (trailed) axles of implements, agricultural machinery or trailers. The type of application is identified with the symbol: 

2.25. "Mixed applications tyre" means a tyre designed to be fitted to either driven and non driven axles of implements, agricultural machinery or trailers;

2.26. "Service description" means the association of a load capacity index with a speed category symbol

2.26.1. In case of implement tyres the service description is supplemented with the relevant symbol for the type of application concerned (traction or trailer) as defined in paragraphs 2.23. and 2.24.

2.27. "Supplementary service description" means an additional service description, marked within a circle, to identify a special type of service (load rating and speed category) to which the tyre type is also allowed in addition to the applicable load variation with speed (see annex 7).

2.28. "Load-capacity index" means one number which indicates the load the tyre can carry in single formation at the speed corresponding to the associated speed category and when operated in conformity with the requirements governing utilisation specified by the manufacturer. The list of these indices and their corresponding masses is given in annex 4;

2.29. "Speed category", the reference speed expressed by the speed category symbol as shown in the table below:

Speed category symbol	Reference speed (km/h)
A2	10
A4	20
A6	30
A8	40
B	50
D	65

- 2.30. "Table: Variation of load capacity with speed" means the tables in annex 7 showing as a function of the category of use, the type of application, the load capacity index and the nominal speed category symbol, the maximum load rating variations which a tyre can withstand when used at speeds different from that corresponding to its speed category symbol;
- 2.30.1. The table "Variation of load capacity with speed" is not applicable to the "supplementary service description".
- 2.31. "Maximum load rating" means the maximum mass the tyre is rated to carry:
- 2.31.1. It must not exceed the percentage of the value associated with the relevant load capacity index of the tyre as indicated in the table "Load-capacity variation with speed" (see paragraph 2.30. above), with reference to the category of use, the speed category symbol of the tyre and the speed capability of the vehicle to which the tyre is fitted.
- 2.32. "Tread groove" means the space between the adjacent ribs or blocks in the tread pattern;
- 2.33. "Tread lug (or cleat)" means the solid-block element protruding from the base of the tread pattern;
- 2.34. "Special tread" means a tyre, the tread pattern and structure of which are primarily designed to ensure in marshy areas a better grip than that of a standard tread tyre. The tread pattern of the tyre generally consists of lugs or cleats deeper than those of a standard tyre;
- 2.35. "Chunking" means the breaking away of small pieces of rubber from the tread;
- 2.36. "Cord separation" means the parting of the cords from their rubber coating;
- 2.37. "Ply separation" means the parting of adjacent plies;
- 2.38. "Tread separation" means the pulling away of the tread from the carcass;
- 2.39. "Test rim" means the rim on which a tyre must be fitted for the performance test.
- 2.40. "Tyre classification code" means the optional marking detailed in annex 10 that identifies the category of use and the particular type of tread pattern and application as specified by ISO 4251-4.

3. MARKINGS

3.1. Tyres must bear:

- 3.1.1. the manufacturer's trade name or mark;
- 3.1.2. the tyre-size designation as defined in paragraph 2.15.;
- 3.1.3. an indication of the structure as follows:
 - 3.1.3.1. on diagonal (bias-ply) tyres, no additional marking;
 - 3.1.3.2. on radial-ply tyres, optionally, the word "RADIAL";
 - 3.1.3.3. on bias-belted tyres, the words "BIAS-BELTED";
- 3.1.4. the "service description" as defined in paragraph 2.26.
 - 3.1.4.1. in the case of implement tyre, the service description must be supplemented with the relevant application symbol;
 - 3.1.4.2. in the case of implement tyre for mixed applications the tyre must be marked with two service descriptions one for "trailer" applications and the other for "traction" applications, each supplemented with the relevant symbol as follows:

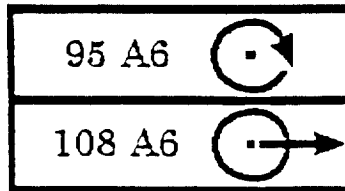

where the first service description (95 A6) refers to "traction applications" and the second (108 A6) to "trailer applications".

- 3.1.5. the supplementary service description, if applicable.
- 3.1.6. the inscription "DEEP" (or "R-2" or "LS-3") in the case of a special tread tyre;
- 3.1.7. the inscriptions "F-1" or "F-2" or "F-3" in the case of a Tractor steering wheel tyre that is not already marked as per paragraph 2.15.6. above;
- 3.1.8. the inscription "IMPLEMENT" in the case of an implement tyre that is not already marked as per paragraph 2.15.5. above;
- 3.1.9. the word "TUBELESS" if the tyre is designed for use without an inner tube;

- 3.1.10. on tractor drive wheel tyres and, if applicable, on implement traction tyres an arrow indicating the preferred direction of rotation of the tyre;
- 3.1.11. the inscription '...bar MAX.' inside the pictogram shown in annex 11, to notify the cold inflation pressure that shall not be exceeded for bead seating during tyre mounting.
- 3.2. The tyre must also be marked with the date of manufacture in the form of a group of four digits, the first two showing the week and the last two the year of manufacture. However, this marking shall not be mandatory on any tyre submitted for approval until two years after the date of entry into force of this Regulation. ^{1/}
- 3.3. The tyre must also bear the ECE tyre type approval mark, the model of which is given in annex 2.
- 3.4. Position of markings
- 3.4.1. The markings referred to in paragraph 3.1. shall be moulded on both sidewalls of the tyre.
- 3.4.2. The markings referred to in paragraphs 3.2. and 3.3. shall be moulded on one sidewall only.
- 3.4.3. All markings must be clearly and legibly moulded and produced as part of the process during manufacture. The use of branding or other methods of marking after completion of the original manufacturing process is not permitted.
- 3.5. Annex 3 gives examples of the arrangement of tyre markings.
4. APPLICATION FOR APPROVAL
- 4.1. The application for approval of a type of tyre for agricultural and forestry services shall be submitted by the holder of the trade name or mark or by his duly accredited representative. It shall specify:
- 4.1.1. The tyre size designation as defined in paragraph 2.15. of this Regulation.
- 4.1.2. The trade name or mark.
- 4.1.3. The category of use as defined in paragraph 2.1.3. of this Regulation.

^{1/} Before 1 January 2000, the date of manufacture may be indicated by a group of three digits, the first two showing the week and the last one the year of manufacture.

- 4.1.4. The structure.
- 4.1.5. The speed category symbol.
- 4.1.6. The load-capacity index of the tyre, specifying in case of implement tyres that for traction (only) and that for trailer application, if applicable.
- 4.1.7. Whether the tyre is to be fitted with or without an inner tube.
- 4.1.8. The supplementary service description, if applicable.
- 4.1.9. The tyre/rim configuration.
- 4.1.10. The rim to be used for measurements and the rim to be used for tests.
- 4.1.11. The rim(s) on which the tyre can be mounted.
- 4.1.12. The inflation pressure (bar) for measurements.
- 4.1.13. The factor X referred to in paragraph 2.18. or the applicable table of annex 5.
- 4.1.14. The cold inflation pressure that shall not be exceeded for bead seating during tyre mounting, as specified by the tyre manufacturer for the tyre type.
- 4.1.15. The test pressure, in kPa (or in bar).
- 4.2. On request of the approval authority, the tyre manufacturer must also submit a complete technical file for each tyre type containing in particular sketches or photographs (three copies) to identify the tread pattern and the envelope of the inflated tyre mounted on the measuring rim showing the relevant dimensions (see paragraphs 6.1. and 6.2.) of the component type submitted for approval. It shall also either contain the test report issued by an approved test laboratory or be accompanied by one sample of the tyre type, as requested by the approval authority.
- 5. APPROVAL
 - 5.1. If the type of pneumatic tyre submitted for approval in pursuance to this Regulation meets the requirements of paragraph 6 below, approval of that type of tyre shall be granted.
 - 5.2. An approval number shall be assigned to each type approved; its first two digits (at present 00 for the Regulation in its original form) shall indicate the series of amendments incorporating the most recent major technical amendments made to the Regulation at the time of issue of the approval. The same Contracting Party may not assign the same number to another type of pneumatic tyre.

- 5.3. Notice of approval or of refusal of approval of a type of pneumatic tyre pursuant to this Regulation shall be communicated to the Parties to the Agreement which apply this Regulation by means of a form conforming to the model in annex 1 to this Regulation and of a photograph or of drawings supplied by the applicant for approval, in a format not exceeding A4 (210 x 297 mm) or folded to that format and on an appropriate scale.
- 5.4. There shall be affixed, conspicuously, to every pneumatic tyre conforming to a type of tyre approved under this Regulation, in the space referred to in paragraph 3.3. above and in addition to the markings prescribed in paragraphs 3.1. and 3.2. above, an international approval mark consisting of:
- 5.4.1. A circle surrounding the letter "E" followed by the distinguishing number of the country which has granted approval. 2/
- 5.4.2. An approval number.
- 5.5. The approval mark shall be clearly legible and be indelible.
- 5.6. Annex 2 to this Regulation gives an example of the arrangement of the approval mark.

6. REQUIREMENTS

- 6.1. Section width of a tyre
- 6.1.1. Except as provided by paragraph 6.1.2., the section width is calculated by the following formula:

$$S = S_1 + K (A-A_1)$$

where:

S is the "section width" expressed in mm related to the measuring rim;

2/ 1 for Germany, 2 for France, 3 for Italy, 4 for the Netherlands, 5 for Sweden, 6 for Belgium, 7 for Hungary, 8 for the Czech Republic, 9 for Spain, 10 for Yugoslavia, 11 for the United Kingdom, 12 for Austria, 13 for Luxembourg, 14 for Switzerland, 15 (vacant), 16 for Norway, 17 for Finland, 18 for Denmark, 19 for Romania, 20 for Poland, 21 for Portugal, 22 for the Russian Federation, 23 for Greece, 24 (vacant), 25 for Croatia, 26 for Slovenia, 27 for Slovakia, 28 for Belarus, 29 for Estonia, 30 (vacant), 31 for Bosnia and Herzegovina, 32-36 (vacant), 37 for Turkey, 38-39 (vacant) and 40 for The former Yugoslav Republic of Macedonia. Subsequent numbers shall be assigned to other countries in the chronological order in which they ratify or accede to the Agreement concerning the Recognition of Approval for Motor Vehicle Equipment and Parts, and the numbers thus assigned shall be communicated by the Secretary-General of the United Nations to the Contracting Parties to the Agreement.

- S1 is the "nominal section width" in mm as shown on the sidewall of the tyre in the tyre-size designation as prescribed;
A is the width (expressed in mm) $\frac{3}{4}$ of the measuring rim, as shown by the manufacturer in the descriptive note,
A1 is the width (expressed in mm) $\frac{3}{4}$ of the theoretical rim; it is taken to equal S1 multiplied by the factor X as specified by the tyre manufacturer
and K is taken to equal 0.4.
- 6.1.2. However, for the types of tyre for which the size designation is given in the first column of the tables in annex 5, the theoretical rim width (A1) and the nominal section width (S1) are given opposite the tyre size designation in those tables.
- 6.2. Outer diameter of a tyre
- 6.2.1. Except as provided by paragraph 6.2.2., the outer diameter of a tyre is calculated by the following formula:
- $$D = d + 2 H$$
- where:
- D is the outer diameter expressed in mm,
d is the conventional number denoting the nominal rim diameter expressed in mm (see paragraph 2.16.),
H is the nominal section height in mm and is equal to:
- $$H = 0.01 \times Ra \times S1$$
- where:
- Ra is the nominal aspect ratio,
S1 is the "nominal section width" in mm
- all as shown on the sidewall of the tyre in the tyre-size designation in conformity with the requirements of paragraph 2.15.
- 6.2.2. However, for the types of tyres for which the size designation is given in the first column of the tables of annex 5 the outer diameter (D) and the nominal rim diameter (d) expressed in mm are given opposite the tyre size designation in those tables.
- 6.3. Tyre section width: specification of tolerances
- 6.3.1. The overall width of a tyre may be less than the section width determined pursuant to paragraph 6.1., or shown in annex 5;

$\frac{3}{4}$ Conversion factor from code to mm is 25.4.

6.3.2. The overall width of a tyre may not exceed the section width determined pursuant to paragraph 6.1. by more than the following:

Radial construction: + 5%
 Diagonal (bias) construction: + 8%

6.3.3. However, for the types of tyre for which the size designation is given in the first column of the tables in annex 5, the allowed percentages are those given in the relevant tables, if any.

6.4. Tyre outer diameter: specification of tolerances

6.4.1. The outer diameter of a tyre must not be outside the values D min and D max obtained from the following formulae:

$$D \text{ min} = d + 2 (H \times a)$$

$$D \text{ max} = d + 2 (H \times b)$$

where "H" and "d" are as defined in paragraph 6.2.1.

6.4.1.1. for sizes listed in annex 5: $H = 0,5 (D - d)$
 (for references see paragraph 6.2. above).

6.4.2. coefficients "a" and "b" are respectively:

Category of use	Radial		Diagonal (bias)	
	a	b	a	b
Steering wheels	0,96	1,04	0,96	1,07
Drive wheels - normal	0,96	1,04	0,96	1,07
Drive wheels - special	1,00	1,12	1,00	1,12
Implement	0,96	1,04	0,96	1,07

6.5. Test procedures

6.5.1. The actual dimensions of tyres are measured as prescribed in annex 6.

6.5.2. The test procedure to assess the resistance of the tyre to burst is described in annex 8.

6.5.2.1. A tyre which, after undergoing the relevant test to assess the resistance to burst, does not exhibit any tread separation, ply separation, cord separation, broken beads or broken cords is deemed to have passed the test. The tyre tested shall not be used for any other tests.

- 6.5.3. The test procedures to assess the suitability of the tyre for the claimed performances are described in annex 9.
- 6.5.3.1. A tyre which, after undergoing the relevant load/speed test, does not exhibit any tread separation, ply separation, cord separation or broken cords is deemed to have passed the test. The tyre tested shall not be used for any other tests.
- 6.5.3.2. A tyre which, after undergoing the relevant load/speed test, does exhibit chunking, due to the specific test conditions is deemed to have passed the test.
- 6.5.4. Where a tyre manufacturer produces a range of tyres it is not considered necessary to carry out tests on every type of tyre in the range.
7. MODIFICATION OF TYRE TYPE AND EXTENSION OF APPROVAL
- 7.1. Every modification of a tyre type shall be notified to the administrative department which approved the tyre type. That department may then either:
- 7.1.1. Consider that the modifications made are unlikely to have an appreciable adverse effect and that in any case the tyre still meet the requirements; or
- 7.1.2. Require a further test report from the technical service responsible for carrying out the tests.
- 7.2. A modification of the tread pattern of the tyre shall not be considered to necessitate a repetition of the tests prescribed in paragraph 6 of this Regulation.
- 7.3. Confirmation or refusal of approval, specifying the alterations, shall be communicated by the procedure specified in paragraph 5.3. above to the Parties to the Agreement which apply this Regulation.
- 7.4. The competent authority issuing the extension of approval shall assign a series number for such an extension and inform thereof the other Parties to the 1958 Agreement applying this Regulation by means of a communication form conforming to the model in annex 1 to this Regulation.

8. CONFORMITY OF PRODUCTION

The conformity of production procedures shall comply with those set out in the Agreement, Appendix 2 (E/ECE/324-E/ECE/TRANS/505/Rev.2), with the following requirements:

- 8.1. The pneumatic tyres approved under this Regulation shall be so manufactured as to conform to the type approved by meeting the requirements set forth in paragraph 6 above.
- 8.2. The authority which has granted type approval may at any time verify the conformity control methods applied in each production facility. For each production facility, the normal frequency of these verifications shall be once every two years.

9. PENALTIES FOR NON CONFORMITY OF PRODUCTION

- 9.1. The approval granted in respect of a type of pneumatic tyre pursuant to this Regulation may be withdrawn if the requirement laid down in paragraph 8.1. above is not complied with or if the tyres taken from the series have failed to pass the tests prescribed in that paragraph.
- 9.2. If a Party to the Agreement which applies this Regulation withdraws an approval it has previously granted, it shall forthwith so notify the other Contracting Parties which apply this Regulation, by means of a communication form conforming to the model in annex 1 to this Regulation.

10. PRODUCTION DEFINITELY DISCONTINUED

If the holder of an approval completely ceases to manufacture a type of pneumatic tyre approved in accordance with this Regulation, he shall so inform the authority which granted the approval. Upon receiving the relevant communication that authority shall inform thereof the other Parties to the Agreement which apply this Regulation by means of a communication form conforming to the model in annex 1 to this Regulation.

11. NAMES AND ADDRESSES OF TECHNICAL SERVICES RESPONSIBLE FOR CONDUCTING APPROVAL TESTS, OF TEST LABORATORIES, AND OF ADMINISTRATIVE DEPARTMENTS

- 11.1. The Parties to the Agreement which apply this Regulation shall communicate to the United Nations Secretariat the names and addresses of the technical services responsible for conducting approval tests and, where applicable, of the approved test laboratories and of the administrative departments which grant approval and to which forms certifying approval or refusal or withdrawal of approval, issued in other countries, are to be sent.

- 11.2. The Parties to the Agreement which apply this Regulation may use laboratories of tyre manufacturers and may designate, as approved test laboratories, those among them which are situated on their territory or on the territory of another Party to the Agreement subject to a preliminary agreement to this procedure by the competent administrative department of the latter.
- 11.3. Where a Party to the Agreement applies paragraph 11.2. above, it may, if it so desires, be represented at the tests by one or more persons of its choice.

Explanatory figure
(see paragraphs 2.2.and 4.1)

Tyre cross Section

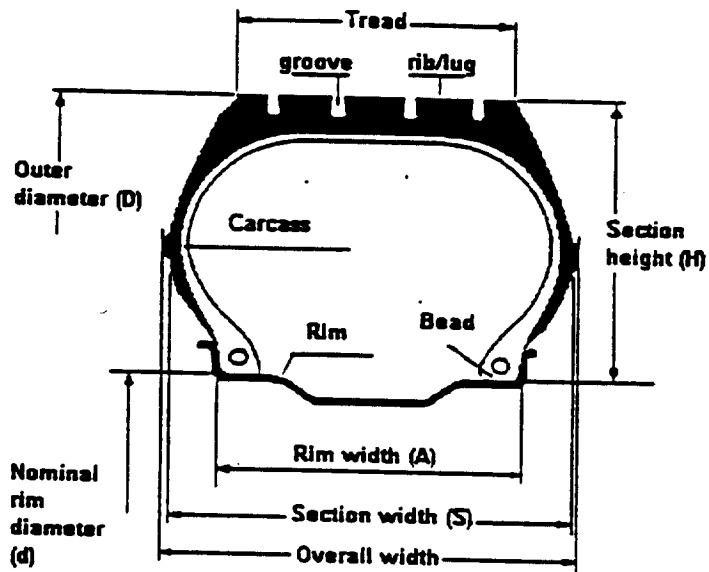

Lug (cleat) tread pattern



Circumferential Rib tread pattern

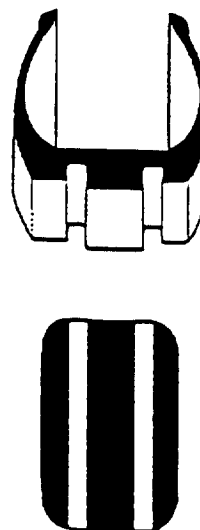

Annex 1

COMMUNICATION

(maximum format: A4 (210 x 297 mm))

issued by: Name of administration:



concerning: 2/ APPROVAL GRANTED
 APPROVAL EXTENDED
 APPROVAL REFUSED
 APPROVAL WITHDRAWN
 PRODUCTION DEFINITELY DISCONTINUED

of a type of pneumatic tyre for motor vehicles pursuant to Regulation No. 106

Approval No. ...

Extension No. ...

1. Manufacturer's name or trade mark(s) on the tyre:
2. Tyre type designation by the manufacturer:
3. Manufacturer's name and address:
4. If applicable, name and address of manufacturer's representative:

5. Summarized description:
 - 5.1. Size of tyre:
 - 5.2. Category of use:
 - 5.3. Structure: diagonal (bias-ply)/bias belted/radial 2/
 - 5.4. Speed category symbol:
 - 5.5. Load-capacity index:
 - 5.5.1. for traction (implement only):
 - 5.5.2. for trailer (implement only):
 - 5.6. Whether the tyre is to be fitted with or without an inner tube

 - 5.7. The supplementary service description, if applicable:

- 6. Technical service and, where applicable, test laboratory approved for purposes of approval or of verification of conformity:
- 7. Date of report issued by that service:
- 8. Number of report issued by that service:
- 9. Reason(s) of extension (if applicable):
- 10. Any remarks:
- 11. Place:
- 12. Date:
- 13. Signature:
- 14. Annexed to this communication is a list of documents in the approval file deposited at the Administrative Services having delivered the approval and which can be obtained upon request.

1/ Distinguishing number of the country which has granted/extended/refused/withdrawn approval (see approval provisions in the Regulation).

2/ Strike out what does not apply.

Annex 2

ARRANGEMENT OF APPROVAL MARK

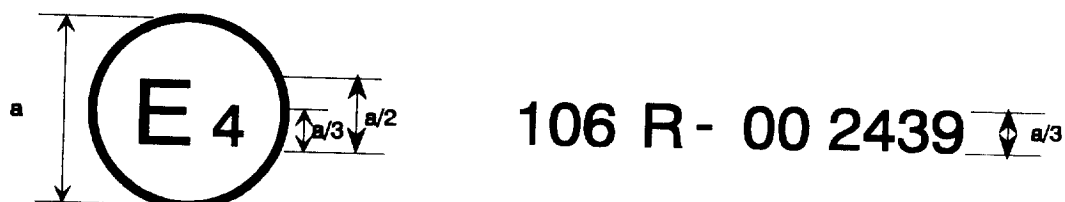

a = 12 mm min

The above approval mark affixed to a pneumatic tyre shows that the type of tyre concerned has been approved in the Netherlands (E 4) pursuant to Regulation No. 106 under approval number 002439. The first two digits of the approval number indicate that the approval was granted in accordance with the requirements of Regulation No. 106 in its original form.

Note: The approval number must be placed close to the circle and either above or below the "E" or to the left or right of that letter. The digits of the approval number must be on the same side of the "E" and face in the same direction. The use of Roman numerals as approval numbers should be avoided so as to prevent any confusion with other symbols.

Annex 3

ARRANGEMENT OF TYRE MARKINGS

(see paragraphs 3.1. and 3.2.)

PART A: DRIVE WHEEL TYRES FOR AGRICULTURAL AND FORESTRY TRACTORS

Example of the markings to be borne by types of tyres complying with this Regulation

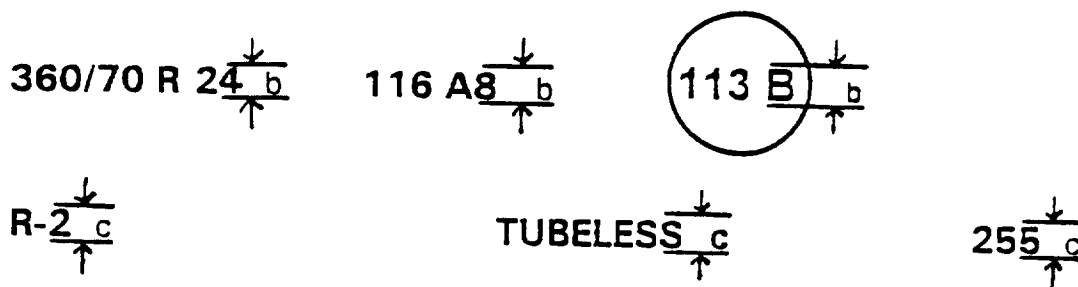

MINIMUM HEIGHTS OF MARKINGS (mm)

	Tyres of rim diameter code <20 (508 mm) or of nominal section width ≤ 230 mm	Tyres of rim diameter code ≥ 20 (508 mm) or of nominal section width > 230 mm
b	6	9
c	4	

These markings define a Drive wheel tyre:

- having a nominal section width of 360,
- having a nominal aspect ratio of 70,
- of radial ply structure (R),
- having a nominal rim diameter of 610 for which the code is 24,
- having a load capacity of 1250 kg, corresponding to load index 116 in annex 4,
- classified in the speed category A8 (reference speed 40 km/h), allowed to be used additionally at 50 km/h (speed category symbol B) with a load capacity of 1150 kg corresponding to the load capacity index 113 shown in annex 4,
- for fitting without an inner tube ("tubeless"),
- having a special tread ("R-2"),
- manufactured during the twenty-fifth week of the year 1995 (see paragraph 3.2. of the Regulation).

The positioning and order of the markings constituting the tyre designation are as follows:

- (a) the size designation, comprising the nominal section width, the nominal aspect ratio, the type of structure symbol (where applicable) and the nominal rim diameter, must be grouped as shown in the above example:
360/70 R 24;
- (b) the service description (load index and the speed category symbol) is placed near the size designation. It may either precede or follow it or be placed above or below it;
- (c) the symbols "TUBELESS", "R-2" or "DEEP", the optional word "RADIAL" and the date of production may be at a distance from the size designation.

* * *

PART B: STEERING WHEEL TYRES FOR AGRICULTURAL
 AND FORESTRY TRACTORS

Example of the markings to be borne by types of tyres
 complying with this Regulation

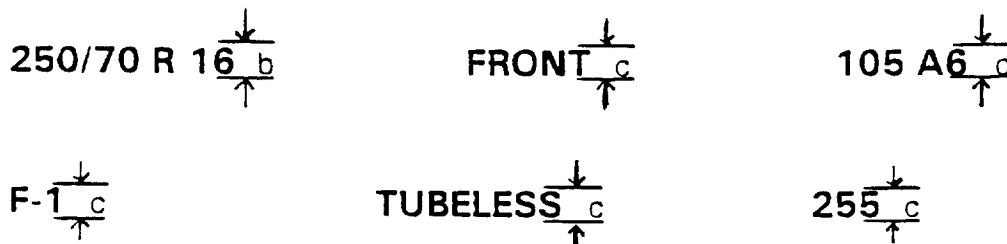

MINIMUM HEIGHTS OF MARKINGS (mm)

	Tyres of rim diameter code < 13 (330 mm) or of nominal section width ≤ 130 mm	Tyres of rim diameter code < 20 (508 mm) or of nominal section width ≤ 235 mm	Tyres of rim diameter code ≥ 20 (508 mm) or of nominal section width > 235 mm
b	4	6	9
c	4		

These markings define a steering wheel tyre:

- having a nominal section width of 250,
- having a nominal aspect ratio of 70,
- of radial-ply structure (R),
- having a nominal rim diameter of 405 mm, for which the code is 16, designed for the equipment of non driven steering axles of agricultural tractors (FRONT)
- having load capacities of 925 kg, corresponding to the load capacity index 105 shown in annex 4,
- classified in the nominal speed category A6 (reference speed 30 km/h),
- for fitting without an inner tube "tubeless", and
- manufactured during the twenty-fifth week of the year 1995 (see paragraph 3.2. of the Regulation).

The positioning and order of the markings constituting the tyre designation are as follows:

- (a) the size designation, comprising the nominal section width, the nominal aspect ratio, the type-of-structure symbol (where applicable), the nominal rim diameter and, optionally the letters "FRONT", must be grouped as shown in the above example: 250/70 R 16 FRONT;
- (b) the service description (the load index and the speed category symbol) is placed together near the size designation. It may either precede or follow it or be placed above or below it;
- (c) the symbol "TUBELESS", the optional word "RADIAL", the optional symbol "F-1", and the date of manufacture may be at a distance from the size designation.

* * *

PART C: IMPLEMENT TYRES

Example of the markings to be borne by types of tyres complying with this Regulation

250/70 R 20 IMP b

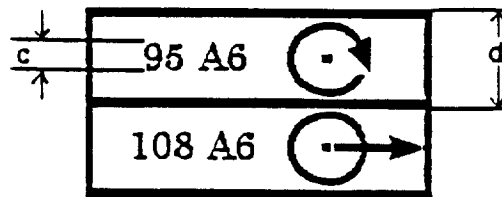

MINIMUM HEIGHTS OF MARKINGS (mm)

	Tyres of rim diameter code < 13 (330 mm) or of nominal section width ≤ 130 mm	Tyres of rim diameter code < 20 (508 mm) or of nominal section width ≤ 235 mm	Tyres of rim diameter code ≥ 20 (508 mm) or of nominal section width > 235 mm
b	4	6	9
c	4		
d	7	12	

These markings define an implement tyre:

- having a nominal section width of 250,
- having a nominal aspect ratio of 70,
- of radial-ply structure (R),
- having a nominal rim diameter of 508 mm, for which the code is 20,
- designed primarily for the equipment of implements, agricultural machinery or agricultural trailers (IMP),
- having load capacities of 690 kg corresponding to the load capacity index 95 shown in annex 4 when used on driven axles (traction application), as identified by the appropriate symbol,
- having load capacities of 1000 kg when used on non driven axles (trailer application) corresponding to the load capacity index 108 shown in annex 4, as identified by the appropriate symbol,
- both applications being classified in the nominal speed category A6 (reference speed 30 km/h),

- for fitting without an inner tube "tubeless", and
- manufactured during the twenty-fifth week of the year 1995
(see paragraph 3.2. of the Regulation).

The positioning and order of the markings constituting the tyre designation are as follows:

- (a) the size designation, comprising the nominal section width, the nominal aspect ratio, the type-of-structure symbol (where applicable), the nominal rim diameter and optionally the letters 'IMP' must be grouped as shown in the above example: 250/70 R 20 IMP;
 - (b) the service description (the load index and the speed category symbol) and the relevant type of application symbol are placed together near the size designation. They may either precede or follow it or be placed above or below it;
 - (c) the symbol "TUBELESS", the optional word "RADIAL", the optional word "IMPLEMENT" and the date of manufacture may be at a distance from the size designation;
-

Annex 4
 LIST OF LOAD CAPACITY INDICES (LI) AND CORRESPONDING MAXIMUM MASS
 TO BE CARRIED (kg) (see paragraph 2.28.)

<i>LI</i>	<i>kg</i>	<i>LI</i>	<i>kg</i>	<i>LI</i>	<i>kg</i>	<i>LI</i>	<i>kg</i>
1	46,2	51	195	101	825	151	3450
2	47,5	52	200	102	850	152	3550
3	48,7	53	206	103	875	153	3650
4	50	54	212	104	900	154	3750
5	51,5	55	218	105	925	155	3875
6	53	56	224	106	950	156	4000
7	54,5	57	230	107	975	157	4125
8	56	58	236	108	1000	158	4250
9	58	59	243	109	1030	159	4375
10	60	60	250	110	1060	160	4500
11	61,5	61	257	111	1090	161	4625
12	63	62	265	112	1120	162	4750
13	65	63	272	113	1150	163	4875
14	67	64	280	114	1180	164	5000
15	69	65	290	115	1215	165	5150
16	71	66	300	116	1250	166	5300
17	73	67	307	117	1285	167	5450
18	75	68	315	118	1320	168	5600
19	77,5	69	325	119	1360	169	5800
20	80	70	335	120	1400	170	6000
21	82,5	71	345	121	1450	171	6150
22	85	72	355	122	1500	172	6300
23	87,5	73	365	123	1550	173	6500
24	90	74	375	124	1600	174	6700
25	92,5	75	387	125	1650	175	6900
26	95	76	400	126	1700	176	7100
27	97,5	77	412	127	1750	177	7300
28	100	78	425	128	1800	178	7500
29	103	79	437	129	1850	179	7750
30	106	80	450	130	1900	180	8000
31	109	81	462	131	1950	181	8250
32	112	82	475	132	2000	182	8500
33	115	83	487	133	2060	183	8750
34	118	84	500	134	2120	184	9000
35	121	85	515	135	2180	185	9250
36	125	86	530	136	2240	186	9500
37	128	87	545	137	2300	187	9750
38	132	88	560	138	2360	188	10000
39	136	89	580	139	2430	189	10300
40	140	90	600	140	2500	190	10600
41	145	91	615	141	2575	191	10900
42	150	92	630	142	2650	192	11200
43	155	93	650	143	2725	193	11500
44	160	94	670	144	2800	194	11800
45	165	95	690	145	2900	195	12150
46	170	96	710	146	3000	196	12500
47	175	97	730	147	3075	197	12850
48	180	98	750	148	3150	198	13200
49	185	99	775	149	3250	199	13600
50	190	100	800	150	3350	200	14000

Annex 5

THEORETICAL RIM, OUTER DIAMETER AND NOMINAL SECTION WIDTH OF TYRES
OF CERTAIN SIZE DESIGNATIONS

Table 1 - Agricultural Steering Wheels - Normal and Low Section Sizes

Tyre size Designation	Theoretical rim width code (A1)	Nominal Width (S1) (mm)	Overall diameter (D) (mm)	Nominal rim Diameter (d) (mm)
4.00 - 9	3	112	460	229
4.00 - 12	3	112	535	305
4.00 - 15	3	112	610	381
4.00 - 16	3	112	630	406
4.00 - 19	3	112	712	483
4.50 - 10	3	121	505	254
4.50 - 16	3	122	655	406
4.50 - 19	3	122	736	483
5.00 - 10	3	130	530	254
5.00 - 12	3	130	580	305
5.00 - 15	4	140	655	381
5.00 - 16	4	140	680	406
5.50 - 16	4	150	710	406
6.00 - 14	5	169	688	356
6.00 - 16	4,5	165	735	406
6.00 - 18	4	160	790	457
6.00 - 19	4,5	165	814	483
6.00 - 20	4,5	165	840	508
6.50 - 10	4,5	175	608	254
6.50 - 16	4,5	175	760	406
6.50 - 20	4,5	175	865	508
7.50 - 16	5,5	205	805	406
7.50 - 18	5,5	205	860	457
7.50 - 20	5,5	205	915	508
8.00 - 16	5,5	211	813	406
9.00 - 16	6	234	855	406
9.50 - 20	7	254	978	508
10.00 - 16	8	274	895	406
11.00 - 16	10	315	965	406
11.00 - 24	10	315	1170	610
Low Section				
7.5L - 15	6	210	745	381
8.25/85 - 15	6	210	745	381
9.5L - 15	8	240	785	381
9.5/85 - 15	8	240	785	381
11L - 15	8	280	815	381
11.5/75 - 15	8	280	815	381
7.5L - 16	6	208	746	406
11L - 16	8	279	840	406
14L - 16.1	11	360	985	409
14.0/80 - 16.1	11	360	985	409
14.5/75 - 16.1	11	373	940	409
16.5L - 16.1	14	419	1072	409

- Notes :**
1. Agricultural steering wheels tyres are identified either by suffix "Front" (or "SL") placed after the Tyre size designation (e.g. 4.00 - 9 Front) or by one of the following additional markings added to the Tyre sidewalls: "F - 1", "F - 2" or "F - 3".
 2. Tyres of radial structure are identified by means of the letter "R" in place of " - " (e.g. 4.00R9)

Table 2 (1 of 3) - Drive wheel Tyres for agricultural tractors - Normal Section Sizes

Tyre size Designation	Theoretical rim width code (A1)	Nominal section Width (S1) (mm)		Overall Diameter (D) (mm)		Nominal rim Diameter (d) (mm)
		Radial	Diagonal	Radial	Diagonal	
4.00 - 7	3		112		410	178
4.00 - 8	3		112		435	203
4.00 - 9	3		112		460	229
4.00-10	3		112		485	254
4.00-12	3		112		535	305
4.00-18	3		112		690	457
4.00-12	3		121		505	254
5.0 -10	4		135		505	254
5.00-10	3		130		530	254
5.00-12	4		145		580	305
5.00-15	4		145		645	381
6.00-12	4		160		635	305
6.00-16	4		160		735	406
6.5-15	5		167		685	381
6.50-16	5		175		760	406
7.50-18	5,5		205		860	457
8.00-20	6		220		965	508
5-12	4		127		545	305
5-14	4		127		595	356
5-26	4		127		900	660
6-10	5		157		550	254
6-12	5		157		600	305
6-14	5		157		650	356
7-14	5		173		690	356
7-16	6		183		740	406
8-16	6		201		790	406
8-18	7		211		840	457
7.2-20	6		183		845	508
7.2-24	6		183		945	610
7.2-30	6		183		1095	762
7.2-36	6		183		1250	914
7.2-40	6		183		1350	1016
8.3-16	7		211		790	406
8.3-20	7		211		890	508
8.3-22	7		211		940	559
8.3-24	7	211	211	985	995	610
8.3-26	7		211		1045	660
8.3-28	7		211		1095	711
8.3-32	7	211	211	1190	1195	813
8.3-36	7	211	211	1290	1300	914
8.3-38	7		211		1350	965
8.3-42	7	211	211	1440	1450	1067
8.3-44	7	211	211	1495	1500	1118
9.5-16	8		241		845	406
9.5-18	8		241		895	457

Tyre size Designation	Theoretical rim width code (A1)	Nominal section Width (S1) (mm)		Overall Diameter (D) (mm)		Nominal rim Diameter (d) (mm)
		Radial	Diagonal	Radial	Diagonal	
9.5-20	8	241	241	940	945	508
9.5-22	8		241		995	559
9.5-24	8	241	241	1040	1050	610
9.5-26	8		241		1100	660
9.5-28	8	241		1140		711
9.5-32	8		241		1250	813
9.5-36	8	241	241	1345	1355	914
9.5-38	8		241		1405	965
9.5-42	8		241		1505	1067
9.5-44	8	241	241	1550	1555	1118
9.5-48	8	241	241	1650	1655	1219

Table 2 (2 of 3) - Drive wheel Tyres for agricultural tractors - Normal Section Sizes

Tyre size Designation	Theoretical rim width code (A1)	Nominal section Width (S1) (mm)		Overall Diameter (D) (mm)		Nominal rim Diameter (d) (mm)
		Radial	Diagonal	Radial	Diagonal	
11.2-18	10		284		955	457
11.2-20	10	284	284	995	1005	508
11.2-24	10	284	284	1095	1105	610
11.2-26	10		284		1155	660
11.2-28	10	284	284	1200	1205	711
11.2-36	10	284	284	1400	1410	914
11.2-38	10	284	284	1455	1460	965
11.2-42	10	284		1555		1067
11.2-44	10	284		1610		1118
11.2-48	10	284		1710		1219
12.4-16	11		315		956	406
12.4-20	11	315		1045		508
12.4-24	11	315	315	1145	1160	610
12.4-26	11		315		1210	660
12.4-28	11	315	315	1250	1260	711
12.4-30	11		315		1310	762
12.4-32	11	315	315	1350	1360	813
12.4-36	11	315	315	1450	1465	914
12.4-38	11	315	315	1500	1515	965
12.4-42	11		315		1615	1067
12.4-46	11	315		1705		1168
12.4-52	11	315		1860		1321
13.6-16	12		345		1005	406
13.6-24	12	345	345	1190	1210	610
13.6-26	12	345	345	1260	1260	660
13.6-28	12	345	345	1295	1310	711
13.6-36	12	345	345	1500	1515	914
13.6-38	12	345	345	1550	1565	965
13.6-48	12	345		1805		1219
13.9-36	12		353		1478	965

Tyre size Designation	Theoretical rim width code (A1)	Nominal section Width (S1) (mm)		Overall Diameter (D) (mm)		Nominal rim Diameter (d) (mm)
		Radial	Diagonal	Radial	Diagonal	
14.9/80-24	12		368		1215	610
14.9-20	13		378		1265	508
14.9-24	13	378	378	1245	1265	610
14.9-26	13	378	378	1295	1315	660
14.9-28	13	378	378	1350	1365	711
14.9-30	13	378	378	1400	1415	762
14.9-38	13	378	378	1600	1615	965
14.9-46	13	378		1824		1168
15.5-38	14	394	394	1565	1570	965
16.9-24	15	429	429	1320	1335	610
16.9-26	15	429	429	1370	1385	660
16.9-28	15	429	429	1420	1435	711
16.9-30	15	429	429	1475	1485	762
16.9-34	15	429	429	1575	1585	864
16.9-38	15	429	429	1675	1690	965
16.9-42	15	429		1775		1067
18.4-16.1	16		467		1137	409
18.4-24	16	467	467	1395	1400	610
18.4-26	16	467	467	1440	1450	660
18.4-28	16	467	467	1490	1501	711
18.4-30	16	467	467	1545	1550	762
18.4-34	16	467	467	1645	1650	864
18.4-38	16	467	467	1750	1750	965
18.4-42	16	467	467	1850	1850	1067
18.4-46	16	467		1958		1168

Table 2 (3 of 3) - Drive wheel Tyres for agricultural tractors - Normal and Low Section Sizes

Tyre size Designation	Theoretical rim width code (A1)	Nominal section Width (S1) (mm)		Overall Diameter (D) (mm)		Nominal rim Diameter (d) (mm)
		Radial	Diagonal	Radial	Diagonal	
20.8-34	18	528	528	1735	1735	864
20.8-38	18	528	528	1835	1835	965
20.8-42	18	528	528	1935	1935	1067
23.1-26	20	587	587	1605	1605	660
23.1-30	20	587	587	1700	1705	762
23.1-34	20	587	587	1800	1805	864
24.5-32	21	622	622	1800	1805	813
Low Section Height						
7.5L-15	6		210		745	381
17.5L-24	15	445	445	1241	1265	610
19.5L-24	17	495	495	1314	1339	610
21L-24	18		533		1402	610
28.1-26	25		714		1615	660
28L-26	25	719	714	1607	1615	660
30.5L-32	27	775	775	1820	1820	813

- Notes:
1. The Tyre size designation may be supplemented by an additional figure: ex: 23.1/18 - 26 instead of 23.1 - 26.
 2. Tyres of radial structure are identified by means of the letter " R " in place of " - " (e.g. 23.1R26).
 3. Coefficient for the calculation of the overall width: + 8 %

Table 3 - Drive wheel Tyres for agricultural tractors - Low Section Series

Tyre size Designation	Theoretical rim width code (A1)	Nominal section Width (S1) (mm)	Overall diameter (D) (mm)	Nominal rim Diameter (d) (mm)
11.2/78-28	10	296	1180	711
12.4/78-28	11	327	1240	711
12.4/78-36	11	327	1440	914
13.6/78-28	12	367	1285	711
13.6/78-36	12	367	1490	914
14.9/78-28	13	400	1345	711
16.9/78-28	15	452	1410	711
16.9/78-30	15	452	1460	762
16.9/78-34	15	452	1560	864
16.9/78-38	15	452	1665	965
18.4/78-30	16	490	1525	762
18.4/78-38	16	490	1730	965

Table 4 - Drive wheel Tyres for agricultural tractors - Low Section Series

Tyre size Designation	Theoretical rim width code (A1)	Nominal section Width (S1) (mm)	Overall diameter (D) (mm)	Nominal rim Diameter (d) (mm)
260/70R16	8	258	806	406
260/70R18	8	258	858	457
260/70R20	8	258	908	508
300/70R20	9	295	952	508
320/70R20	10	319	982	508
320/70R24	10	319	1094	610
320/70R28	10	319	1189	711
360/70R20	11	357	1042	508
360/70R24	11	357	1152	610
360/70R28	11	357	1251	711
380/70R20	12	380	1082	508
380/70R24	12	380	1190	610
380/70R28	12	380	1293	711
420/70R24	13	418	1248	610
420/70R28	13	418	1349	711
420/70R30	13	418	1398	762
480/70R24	15	479	1316	610
480/70R26	15	479	1372	660
480/70R28	15	479	1421	711
480/70R30	15	479	1478	762
480/70R34	15	479	1580	864
480/70R38	15	479	1681	965
520/70R26	16	516	1456	660
520/70R30	16	516	1536	762
520/70R34	16	516	1640	864
520/70R38	16	516	1749	965
580/70R38	18	577	1827	965

Table 5 (1 of 2) - Agricultural Implement Tyres - Normal Section Sizes

Tyre size Designation	Theoretical rim width code (A1)	Nominal section Width (S1) (mm)	Overall diameter (D) (mm)	Nominal rim Diameter (d) (mm)
125 - 15 IMP	3,5	127	590	381
140 - 6 IMP	4,5	135	315	152
165 - 15 IMP	4,5	167	650	381
2.50 - 4 IMP	1,75	68	225	102
2.75 - 4 IMP	1,75	70	234	102
2.50 - 8 IMP	1,5	68	338	203
3.00 - 4 IMP	2,5	90	265	102
3.00 - 8 IMP	2,5	90	367	203
3.00 - 10 IMP	2,5	90	418	254
3.25 - 8 IMP	2,10	84	366	203
3.25 - 16 IMP	1,85	88	590	406
3.50 - 5 IMP	3	95	292	127
3.50 - 6 IMP	2,5	100	343	152
3.50 - 8 IMP	2,5	100	393	203
3.50 - 16 IMP	1,85	92	590	406
4.00 - 4 IMP	3	114	313	102
4.00 - 5 IMP	3	102	310	127
4.00 - 6 IMP	3	114	374	152
4.00 - 8 IMP	3	112	418	203
4.00 - 9 IMP	3	112	443	229
4.0 - 10 IMP	3	114	455	254
4.00 - 10 IMP	3	114	465	254
4.00 - 12 IMP	3	112	519	305
4.00 - 15 IMP	3	112	595	381
4.00 - 16 IMP	3	114	618	406
4.00 - 18 IMP	3	112	672	457
4.00 - 19 IMP	3	114	694	483
4.00 - 21 IMP	3	112	765	533
4.00/4.50 - 21 IMP	3	110	765	533
4.10 - 4 IMP	3,25	102	268	102
4.10 - 6 IMP	3,25	102	319	152
4.50 - 9 IMP	3	124	466	229
4.50 - 14 IMP	3	124	593	356
4.50 - 16 IMP	3	123	647	406
4.50 - 19 IMP	3	124	720	483
4.80 - 8 IMP	3,75	121	423	203
5.00 - 8 IMP	4	145	467	203
5.00 - 9 IMP	3,5	141	497	229
5.0 - 10 IMP	4	145	505	254
5.0 - 12 IMP	4	145	566	305
5.00 - 12 IMP	4	145	567	305
5.00 - 14 IMP	4	145	618	356
5.0 - 15 IMP	4	145	642	381
5.00 - 15 IMP	3	130	639	381
5.00 - 16 IMP	4	145	669	406
5.00/5.25 - 21 IMP	3	136	824	533
5.50 - 16 IMP	4	150	685	406

Tyre size Designation	Theoretical rim width code (A1)	Nominal section Width (S1) (mm)	Overall diameter (D) (mm)	Nominal rim Diameter (d) (mm)
5.70 - 12 IMP	4,5	146	570	305
5.70 - 15 IMP	4,5	146	647	381
5.90 - 15 IMP	4	150	665	381
6 - 6 IMP	4	145	425	152
6.00 - 9 IMP	4,5	169	543	229
6 - 12 IMP	5	145	585	305
6.0 - 12 IMP	5	155	569	305
6.00 - 12 IMP	5	152	579	305
6.00 - 16 IMP	4	158	712	406
6.00 - 19 IMP	4,5	169	810	483
6.00 - 20 IMP	4,5	169	830	508
6.40 - 15 IMP	4,5	163	684	381
6.5 - 15 IMP	5	163	674	381
6.50 - 10 IMP	5	178	597	254
6.50 - 16 IMP	4,5	173	735	406
6.50 - 20 IMP	5	176	850	508
6.70 - 15 IMP	4,5	182	733	381
6.90 - 9 IMP	5,5	175	545	229
7.00 - 12 IMP	5	187	667	305
7.00 - 14 IMP	5	170	691	356
7.00 - 15 IMP	5,5	200	744	381
7.00 - 16 IMP	5,5	200	769	406
7.00 - 18 IMP	5,5	200	820	457
7.00 - 19 IMP	5,5	200	845	483
7.50 - 10 IMP	6	214	634	254
7.50 - 14 IMP	5,5	194	686	356
7.50 - 15 IMP	6	215	808	381
7.50 - 16 IMP	5,5	202	785	406
7.50 - 18 IMP	5,5	202	836	457
7.50 - 20 IMP	5,5	202	887	508
7.50 - 24 IMP	5,5	202	989	610
7.60 - 15 IMP	5,5	193	734	381
8 - 16 IMP	6	211	795	406
8.00 - 6 IMP	7	203	452	152
8.00 - 12 IMP	5	214	710	305
8.00 - 16 IMP	6	206	808	406
8.00 - 19 IMP	6	214	888	483
8.00 - 20 IMP	6	214	945	508
8.25 - 15 IMP	6,5	237	835	381
8.25 - 16 IMP	6	229	832	406
8.25 - 20 IMP	6	229	934	508
9.00 - 10 IMP	6	234	696	254
9.00 - 13 IMP	5,5	247	814	330
9.00- 15 IMP	5,5	247	850	381
9.00 - 16 IMP	6	234	848	406
9.00 - 24 IMP	8	272	1094	610
10.00 - 12 IMP	6,5	262	790	305

Tyre size Designation	Theoretical rim width code (A1)	Nominal section Width (S1) (mm)	Overall diameter (D) (mm)	Nominal rim Diameter (d) (mm)
10.00 - 15 IMP	8	274	853	381
10.00 - 16 IMP	8	274	895	406
10.50 - 16 IMP	6,5	280	955	406
11.00 - 12 IMP	6,5	277	835	305
11.00 - 16 IMP	6,5	277	937	406
11.0 - 20 IMP	9	285	950	508
11.25 - 24 IMP	10	325	1171	610
11.25 - 28 IMP	10	325	1273	711
11.5 - 24 IMP	10	305	1070	610
13.50 - 16.1 IMP	11	353	1021	409
14.0 - 24 IMP	12	370	1170	610
15.0 - 24 IMP	13	400	1210	610
15.0 - 28 IMP	13	400	1310	711
17.0 - 28 IMP	15	455	1390	711
17.0 - 30 IMP	15	455	1440	762
18.5 - 34 IMP	16	490	1600	864
20 - 20 IMP	14	520	1270	508

Table 6 (1 of 2) - Agricultural Implement Tyres - Low Section Sizes

Tyre size Designation	Theoretical rim width code (A1)	Nominal section Width (S1) (mm)	Overall diameter (D) (mm)	Nominal rim Diameter (d) (mm)
7.5 L - 15 IMP	6	210	745	381
8.5 L - 14 IMP	6	216	721	356
9.5 L - 14 IMP	7	241	741	356
9.5 L - 15 IMP	7	241	767	381
11 L - 14 IMP	8	279	752	356
11 L - 15 IMP	8	279	777	381
11 L - 16 IMP	8	279	803	406
12.5 L - 15 IMP	10	318	823	381
12.5 L - 16 IMP	10	318	848	406
14 L - 16.1 IMP	11	356	940	409
16.5 L - 16.1 IMP	14	419	1024	409
19 L - 16.1 IMP	16	483	1087	409
21.5 L - 16.1 IMP	18	546	1130	409

- Notes:**
1. The suffix " IMP " may be replaced by the wording " IMPLEMENT " on the Tyre sidewall
 2. Tyres of radial structure are identified by means of the letter " R " in place of " - " (e.g. 7.5 L R 15).

Table 6 (2 of 2) - Agricultural Implement Tyres - Low Section Sizes

Tyre size Designation	Theoretical rim width code (A1)	Nominal section Width (S1) (mm)	Overall diameter (D) (mm)	Nominal rim Diameter (d) (mm)
205/50 - 10 IMP	7	211	450	254
19.0/45 - 17 IMP	16	491	866	432
15.0/55 - 17 IMP	13	391	850	432
10.5/65 - 16 IMP	9	274	755	406
11.0/60 - 16 IMP	9	281	742	406
11.0/65 - 12 IMP	9	281	670	305
13.0/65 - 18 IMP	11	336	890	457
13.0/70 - 16 IMP	11	337	890	406
14.0/65 - 16 IMP	11	353	870	406
9.0/70 - 16 IMP	7	226	725	406
11.5/70 - 16 IMP	9	290	815	406
11.5/70 - 18 IMP	9	290	865	457
15.0/70 - 18 IMP	13	391	990	457
16.0/70 - 20 IMP	14	418	1075	508
16.5/70 - 22.5 IMP	13	417	1158	572
20.0/70 - 508 IMP	16	508	1220	508
8.0/75 - 15 IMP	6,5	199	710	381
9.0/75 - 16 IMP	7	226	749	406
10.0/75 - 12 IMP	9	264	685	305
10.0 - 15.3 IMP	9	258	785	389
10.0/75 - 15.3 IMP	9	264	760	389
10.0/75 - 16 IMP	9	264	805	406
12.0/75 - 18 IMP	9	299	915	457
13.0/75 - 16 IMP	11	336	900	406
13.5/75 - 430.9 IMP	11	345	945	431
14.5/75 - 20 IMP	12	372	1060	508
6.5/80 - 12 IMP	5	163	569	305
6.5/80 - 15 IMP	5	163	645	381
8.50 - 12 IMP	7	235	715	305
10.0/80 - 12 IMP	9	264	710	305
10 - 18 IMP	9	260	875	457
10.5/80 - 18 IMP	9	274	885	457
11.5 - 15.3 IMP	9	295	860	389
11.5/80 - 15.3 IMP	9	290	845	389
12.5/80 - 15.3 IMP	9	307	889	389
12.5/80 - 18 IMP	9	308	965	457
14.5/80 - 18 IMP	12	372	1060	457
15.5/80 - 24 IMP	13	394	1240	610
17.0/80 - 508 IMP	13	426	1200	508
19.5/80 - 20 IMP	16	499	1300	508
21.0/80 - 20 IMP	16	525	1362	508
5.5/85 - 9 IMP	4	145	475	229
10.5/85 - 15.3 IMP	9	274	792	389
13.5/85 - 28 IMP	11	345	1293	711
16.5/85 - 24 IMP	13	417	1322	610
16.5/85 - 28 IMP	13	417	1423	711

Notes: 1. The suffix " IMP " may be replaced by the wording " IMPLEMENT " on the Tyre sidewall .
2. Tyres of radial structure are identified by means of the letter " R " in place of " - " (e.g. 205/50R10)

Table 7 (1 of 2) - Agricultural High Flotation Tyres

Tyre size Designation	Theoretical rim width code (A1)	Nominal section Width (S1) (mm)	Overall diameter (D) (mm)	Nominal rim Diameter (d) (mm)
9x3.50 - 4	2,75	91	229	101
11x4.00 - 4	3,25	102	280	101
11x4.00 - 5	3	104	272	127
11x7 - 4	6	185	270	101
12x4.00 - 5	3	112	298	127
13x5.00 - 6	3,5	122	320	152
13x6.00 - 8	5	154	330	203
13x6.50 - 6	5	163	330	152
14x5.00 - 6	4	127	347	152
14x6.00 - 6	4,5	157	340	152
15x6.00 - 6	4,5	155	366	152
16x4.50 - 9	3	105	405	229
16x5.50 - 8	4,25	142	414	203
16x6.50 - 8	5,375	165	405	203
16x7.50 - 8	5,375	188	411	203
17x8.00 - 8	7	203	438	203
17x8.00 - 12	7	203	432	305
18x6.50 - 8	5	163	457	203
18x7.00 - 8	5,5	178	450	203
18x8.50 - 8	7	214	450	203
18x9.50 - 8	7	235	462	203
19x7.50 - 8	5,5	180	480	203
19x8.00 - 10	7	203	483	254
19x10.00 - 8	8,5	254	483	203
20x8.00 - 10	7	203	500	254
20x10.00 - 8	8	254	508	203
20x10.00 - 10	8,5	254	508	254
20.5x8.00 - 10	6	208	526	254
21x8.00 - 10	7	203	525	254
AT21x7 - 10	5,5	177	533	254
21x11.00 - 8	8,5	282	518	203
21x11.00 - 10	9	279	525	254
22x8.00 - 10	6	196	556	254
22x8.50 - 12	7	216	551	305
AT22x9 - 8	7	227	559	203
22x10.00 - 8	7	244	572	203
22x10.00 - 10	8,5	254	559	254
22x11.00 - 8	8,5	284	546	203
22x11.00 - 10	8,5	254	559	254
AT23x7 - 10	5,5	175	587	254
AT23x8 - 11	6,5	204	584	279
23x8.50 - 12	7	214	575	305
23x9.00 - 12	7,5	229	575	305
23x10.50 - 12	8,5	264	579	305
AT24x8 - 11	6,5	204	610	279
AT24x9 - 11	7	227	610	279
AT24x10 - 11	8	254	610	279

Tyre size Designation	Theoretical rim width code (A1)	Nominal section Width (S1) (mm)	Overall diameter (D) (mm)	Nominal rim Diameter (d) (mm)
24x8.50 - 12	7	213	602	305
24x8.50 - 14	7	213	602	356
24x11.00 - 10	8,5	254	607	254
24x13.00 - 12	10,5	325	592	305
25x7.50 - 15	5,5	191	640	381
AT25x8 - 12	6,5	204	635	305
25x8.50 - 14	7	213	645	356
25x10.50 - 15	8	267	640	381
AT25x11 - 9	9	281	635	229
AT25x11 - 10	8,5	262	645	254

Table 7 (2 of 2) - Agricultural High Flotation Tyres

Tyre size Designation	Theoretical rim width code (A1)	Nominal section Width (S1) (mm)	Overall diameter (D) (mm)	Nominal rim Diameter (d) (mm)
25X12.00 - 9	10	305	635	229
25x12.50 - 15	10	310	640	381
26x10.00 - 12	10	310	660	305
26x12.00 - 12	10	310	660	305
26x14.00 - 12	12	356	660	305
27x8.50 - 15	7	214	680	381
27x9.50 - 15	7	229	686	381
27x10.50 - 15	8,5	259	691	381
27x10 - 15.3	9	261	685	389
28x9.00 - 15	7	234	710	381
28x13 - 15	11,5	330	711	381
29x12.00 - 15	10	310	742	381
29x12.50 - 15	10	310	742	381
29x13.50 - 15	10	351	742	381
31x11.50 - 15	8	301	793	381
31x12.50 - 15	10	310	792	381
31x13.50 - 15	10	351	782	381
31x13.5 - 15	10	351	782	381
31x15.50 - 15	13	391	792	381
31x15.5 - 15	13	391	792	381
33x12.50 - 15	10	310	843	381
33x15.50 - 15	13	391	843	381
36x13.50 - 15	10	351	909	381
38x14.00 - 20	11	356	991	508
38x18.00 - 20	14	457	991	508
38x20.00 - 16.1	16	488	991	409
41x14.00 - 20	11	356	1067	508
42x25.00 - 20	20,5	622	1080	508
43x13.50 - 22	10	360	1102	559
44x18.00 - 20	14	457	1143	508

Tyre size Designation	Theoretical rim width code (A1)	Nominal section Width (S1) (mm)	Overall diameter (D) (mm)	Nominal rim Diameter (d) (mm)
44x41.00 - 20	36	991	1143	508
48x20.00 - 24	15	457	1245	610
48x25.00 - 20	20,5	635	1245	508
48x31.00 - 20	26	775	1245	508
54x31.00 - 26	26	775	1397	660
66x43.00 - 25	36	1054	1702	635
66x43.00 - 26	36	1054	1702	660
66x44.00 - 25	36	1118	1702	635
67x34.00 - 25	30	864	1727	635
67x34.00 - 26	30	864	1727	660
67x34.00 - 30	30	864	1727	762
68x50.00 - 32	44	1270	1753	813
VA73x44.00 - 32	36	1118	1880	813
DH73x44.00 - 32	36	1118	1880	813

Notes: 1. These Tyres may be classified in categories of use " Tractor Drive Wheels " or " Implement " .

2. Implement Tyres are identified either by suffix " IMP " placed after the Tyre size designation (e.g. 11x4.00 - 4 IMP) or by the word " IMPLEMENT " marked on the Tyre sidewalls .

3. Tyres of radial structure are identified by means of the letter " R " in place of " - " (e.g. 11x4.00 R 4).

Annex 6

TEST METHOD FOR MEASURING TYRE DIMENSIONS

1. The tyre shall be mounted on the measuring rim specified by the manufacturer and is inflated to a pressure specified by the manufacturer.
 - 1.1. To seat the beads do not exceed the inflation pressure marked on the tyre sidewalls.
 - 1.2. Having properly seated tyre beads on the rim, adjust the pressure to the value specified for tyre measurements.
 2. The tyre fitted on its rim is conditioned to the ambient temperature of the laboratory for at least 24 hours.
 3. The pressure is readjusted to the value specified in paragraph 1.
 4. The overall width is measured by calliper at six equally-paced points, account being taken of the thickness of the protective ribs or bands. The highest measurement so obtained is taken as the overall width.
 5. The outer diameter is determined by measuring the maximum circumference and dividing the figure so obtained by π (3,1416).
-

Annex 7

VARIATION OF LOAD CAPACITY WITH SPEED
(see paragraphs 2.30. and 2.31.)

PART A : DRIVE WHEEL TYRES FOR AGRICULTURAL AND FORESTRY TRACTORS

Applicable to tyres classified with categories of use : "Tractor drive wheel"
(see paragraph 2.20.)

Variation of load carrying capacity (%)

Speed (km/h)	Speed category symbol				(1)
	A2	A6 (+)	A8 (+)	D (+)	
10	[0]	+ 40	+ 50	+ 50	+ 58
15	- 6	+ 30	+ 34	+ 34	+ 35
20	- 11	+ 20	+ 23	+ 23	+ 27
25	- 16	+ 7	+ 11	+18.5	+ 20
30	- 20	[0]	+ 7	+15	+ 14
35	- 24	- 10	+ 3	+12	+ 10
40	- 27	- 20	[0]	+ 9,5	+ 6
45	-	-	- 4	+ 7	+ 2
50	-	-	- 9	+ 5	[0]
55	-	-	-	+ 3	-
60	-	-	-	+ 1,5	-
65	-	-	-	[0]	-
70	-	-	-	- 9	-

The above load/speed variations apply when the tyre is not subjected to sustained high torque service.

- (+) For field applications with sustained high torque service the values shown in the line 30 km/h apply.
- (1) These percentages apply only in case of tyres listed in annex 5, Table 7 marked with speed category symbol "B".

PART B : STEERING WHEEL TYRES FOR AGRICULTURAL AND FORESTRY TRACTORS

Applicable to tyres classified with category of use "Tractor steering wheels" and marked "Front" or "SL" or "F-1" or "F-2" or "F-3" (see paragraph 2.21.)

(see paragraphs 2.30. and 2.31.)
 Variation of load carrying capacity (%)

Speed (km/h)	Speed category symbol	
	A6	A8
10	+ 50	+ 67
15	+ 43	+ 50
20	+ 35	+ 39
25	+ 15	+ 28
30	[0]	+11
35	- 10	+ 4
40	- 20	[0]
45	-	- 7

PART C : IMPLEMENT TYRES

Applicable to tyres classified with categories of use: "Implement" and marked "IMP" or "IMPLEMENT" (see paragraph 2.22.)

Variation of load carrying capacity (%)
 (see paragraphs 2.30. and 2.31.)

Speed (km/h)	Speed category symbol			(1)
	A4	A6	A8	
10	+ 20	+ 29	+ 40	+ 58
15	+ 12	+ 21	+33	+ 35
20	[0]	+ 14	+26	+ 27
25	- 2	+ 7	+19	+ 20
30	- 5	[0]	+ 12	+ 14
35		- 5	+ 5	+ 10
40		- 10	[0]	+ 6
45		-	- 5	+ 2
50		-	- 10	[0]

The above load / speed variations apply when the tyre is not subjected to sustained high torque service.

- (1) These percentages apply only in case of tyres listed in annex 5, Table 7 marked with speed category symbol "B".

Annex 8

TEST PROCEDURE
to assess tyre resistance to bursting

1. Preparing the tyre
 - 1.1. Mount a new tyre on the test equipment. Wheels used for the test shall be suitable to withstand, with no deformation, the highest value of pressure achievable during the test.
 - 1.2. Carefully centre the tyre beads on the retention device and adjust the outer distance of the tyre beads to a value corresponding to the width of the rim specified by the manufacturer pursuant to paragraph 4.1.10. of this Regulation.
 - 1.3. Fill the tyre with water taking care that all the air inside the tyre is expelled.
2. Test procedure
 - 2.1. Activate the apparatus and increase the pressure of the water inside the tyre in order to reach progressively the limit given by two and half times the pressure specified by the tyre manufacturer pursuant to paragraph 4.1.12. of this Regulation;
 - 2.1.1. in no case, however, the limit value shall be lower than 6 bar or higher than 10 bar.
 - 2.2. Maintain constant the value of the pressure for at least 10 minutes.
 - 2.3. Decrease, progressively, the pressure of the water to zero and drain the tyre.
 - 2.4. Whilst the pressure of the water inside the tyre is higher than the ambient pressure, nobody shall stand inside the test room, that shall be safely locked.
3. Equivalent test methods

If a method other than that described above is used, its equivalence must be demonstrated.

Annex 9

LOAD/SPEED TEST PROCEDURE

1. Scope and range of application

- 1.1. This test procedure is applicable for new tyres corresponding to the characteristics specified in paragraph 3.4. below.
- 1.2. It serves the purpose to assess the suitability of the tyre for the claimed performances.

2. Preparing the tyre

- 2.1. Mount new tyres on the test rim specified by the manufacturer pursuant to paragraph 4.1.10. of this Regulation.
 - 2.1.1. To seat the beads do not exceed the maximum pressure marked on the tyre sidewalls.
- 2.2. Use a new inner tube when testing tyres with inner tubes (i.e. tyres not bearing the marking "Tubeless").
- 2.3. With the tyre beads properly seated on the rim, inflate the tyre to the pressure corresponding to the test pressure specified by the tyre manufacturer for the type of test programme, pursuant to paragraph 4.1.15. of this Regulation.
- 2.4. Condition the tyre and wheel assembly at test room temperature for not less than three hours.
- 2.5. Readjust the tyre pressure to that specified in paragraph 2.3. above.
- 2.6. On request of the tyre manufacturer proceed with the test programme as specified in either of the following paragraphs:
 - test procedure in a laboratory on a test drum (paragraph 3 below), or
 - test procedure on a road using a trailer (paragraph 4).

3. Test procedure on a test drum

- 3.1. Mount the tyre and wheel assembly on the test axle and press it against the outer face of a smooth power-driven test drum 1.70 m \pm 1 % in diameter having a surface at least as wide as the tyre tread.
 - 3.1.1. Drum widths narrower than the tyre tread pattern may be used if the tyre manufacturer agrees.
- 3.2. Test drum speed : 62.5 revolutions per minute.

3.3. Apply to test axle a series of masses in accordance with the load/speed test programme shown in paragraph 3.4. below, with reference to the test load which equates:

3.3.1. the mass corresponding to load index marked on the tyre in case of tyres marked with speed symbol D.

3.4. Load/speed test programme:

Tyre speed category symbol	test step	percentage of the test load	duration (hours)
D	1	66 %	7
	2	84 %	16
	3	101 %	24

3.5. The tyre pressure must not be corrected throughout the test and the test load must be kept constant throughout each of the three test steps.

3.6. During the test the temperature in the test room must be maintained at between 20 °C and 30 °C or at another temperature if the manufacturer so agrees.

3.7. The load/speed test programme must be carried out without interruption.

4. Test procedure on a trailer

4.1. Mount two new tyres of the same type on a trailer

4.2. Apply on the trailer a mass in order that each tyre be equally loaded with a test load corresponding to the load carrying capacity allowed for that tyre type at 15 km/h (see load variations in annex 7).

4.3. Run the trailer at a constant speed of 15 km/h ± 1 km/h for 48 hours.

4.3.1. Temporary interruptions are allowed, but they must be compensated by an additional run-in of 5 min for every 20 minutes of interruption.

4.4. The tyre pressure must not be corrected and the test load must be kept constant throughout the test.

4.5. During the test the ambient temperature shall be between 5 °C and 30 °C or at another temperature if the manufacturer so agrees.

5. Equivalent test methods

If a method other than those described above is used, its equivalence must be demonstrated.

Annex 10

TYRE CLASSIFICATION CODE
 (Optional marking)

Classification code	Nomenclature
F-1	Agricultural tractor steering wheel tyres : single rib tread
F-2	Agricultural tractor steering wheel tyres : multiple rib tread
F-3	Steering wheel tyres : industrial service (construction application)
G-1	Garden tractor tyres (implement tyres): traction service
G-2	Garden tractor tyres (implement tyres): flotation traction service
G-3	Garden tractor tyres (implement tyres): maximum flotation service
I-1	Agricultural implement tyres : multi-rib tread
I-2	Agricultural implement tyres : moderate traction service
I-3	Agricultural implement tyres : traction tread
I-4	Agricultural implement tyres : plough tail wheel service
I-5	Agricultural implement tyres : steering service
I-6	Agricultural implement tyres : Smooth tread
LS-2	Logging and Forestry service tyres: intermediate tread
LS-3	Logging and Forestry service tyres: deep tread
R-1	Agricultural tractor drive wheel tyres : regular tread
R-2	Agricultural tractor drive wheel tyres : cane and rice service (deep tread)
R-3	Agricultural tractor drive wheel tyres : flotation service (shallow tread)
R-4	Drive wheel tyres : industrial service (construction application)

Annex 11

EXAMPLE OF THE PICTOGRAM TO BE MARKED ON BOTH TYRE SIDEWALLS
 OF THE TYRES TO EXPLICIT THE MAXIMUM INFLATION PRESSURE
 NOT TO BE EXCEEDED FOR BEAD SEATING DURING TYRE MOUNTING

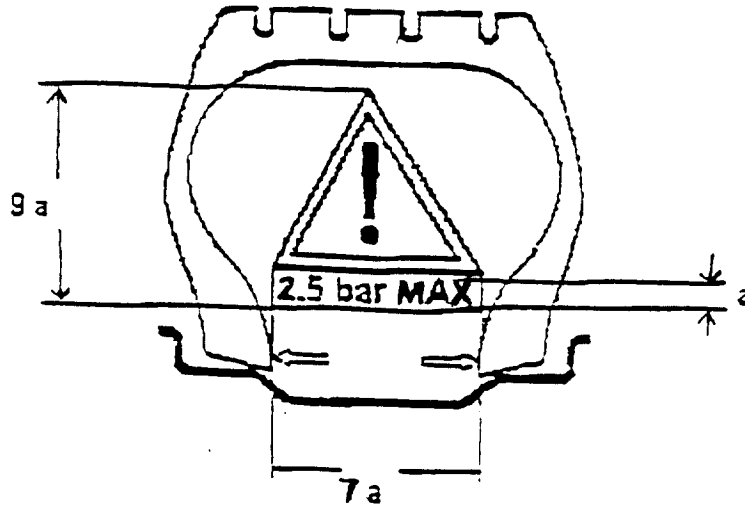

MINIMUM HEIGHTS OF MARKINGS (mm)

	Tyres of rim diameter code < 20 (508 mm) or of nominal section width ≤ 235 mm	Tyres of rim diameter code ≥ 20 (508 mm) or of nominal section width > 235 mm
a	2	4

The pictogram must be placed on both sidewalls.

The value of inflation pressure (2.5 bar in the example) must be the same as specified by the tyre manufacturer in paragraph 4.1.14. of this Regulation.